

## ENTRETOISES DE TUBES PIVOTANTES 2-VOIES - AVEC SUPPORT TUBE

**MATIERES:**

Polyamide, résines acétales

**COULEURS:**

Noir, Naturel (autres couleurs, nous consulter)

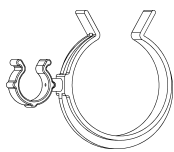
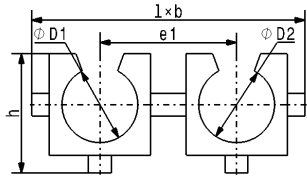

Form 1

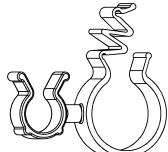

Form 2

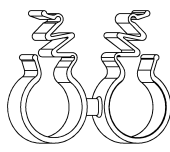

Form 3

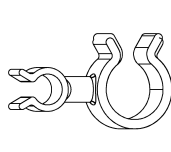

Form 4

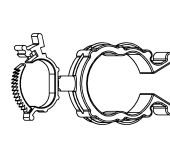

Form 5

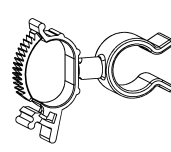

Form 6

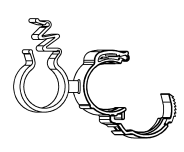

Form 7

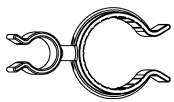

Form 8

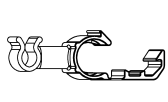

Form 9

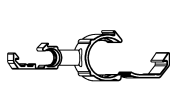

Form 10

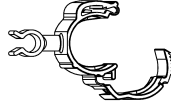

Form 11



Form 12

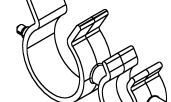

Form 13



Form 14

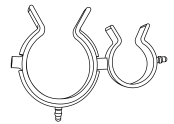

Form 15

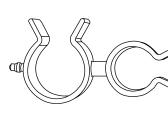

Form 16

Les schémas ne sont donnés qu'à titre d'exemples, seul le dernier plan de chaque pièce est contractuel.

Les supports référencés ci-dessous peuvent recevoir des pièces supplémentaires, qui ne sont pas représentées sur les schémas ci-contre.



**PARTICULARITÉ(S) DE LA PIÈCE**

Voir correspondance des signes page 4  
Dimensions en mm.

Echantillons disponibles sur demande

?	REF.	ØD1	ØD2	l x b	h	e1	Form
E,F	<b>201345</b>	3,5...6	8...9	34,5 x 10	20,0	17,5	1
F	<b>081055</b>	4...4,5	20...24,5	44,25 x 12	28,25	28,5	1
E	<b>082262</b>	4...4,5	23...30	59 x 10	53,25	29,75	1
	<b>080484</b>	4...4,5	4,3...5,2	20,75 x 10	9,5	14,0	1
	<b>060643</b>	4...4,5	4,8...5,2	23 x 10	9,4	14,15	1
F	<b>080489</b>	4...4,5	6...6,5	32 x 8	11,5	22,0	1
	<b>081183</b>	4...4,5	7,8...8,5	24,65 x 12	16,9	15,2	1
	<b>060747</b>	4...4,5	9,5...10,5	27 x 10	17,0	17,0	1
	<b>080455</b>	4...4,5	9,5...10,5	28 x 10	16,0	17,25	1
	<b>080447</b>	4...4,5	11,5...13	30 x 10	17,75	18,25	1
	<b>060855</b>	4...4,5	11...13	29 x 10	18,0	18,7	1
	<b>080453</b>	4...4,5	14...15	32 x 10	21,0	19,5	1
	<b>061074</b>	4...4,5	14...16	39 x 12	22,0	18,0	1
	<b>081232</b>	4...4,5	22...24	40 x 12	29,0	23,5	1
	<b>082388</b>	4,3...5,2	8...9	48 x 10	13,5	39,5	1
	<b>081626</b>	4,3...5,2	11,5...13	29,4 x 10	17,5	18,75	1
F	<b>081490</b>	4,3...5,2	4,3...5,2	28,8 x 10	9,4	22,0	1
	<b>017543</b>	4,3...5,2	6...6,5	23,35 x 10	12,0	15,0	1
F	<b>082185</b>	4,3...5,2	9,5...10,5	44,5 x 10	16,0	34,25	1
	<b>081299</b>	4,3...5,2	14...15	32,4 x 10	21,0	20,0	1
	<b>081226</b>	4,3...5,2	4,3...5,2	21,25 x 10	9,4	14,5	1
	<b>081751</b>	4,3...5,2	6...6,5	23,9 x 10	11,5	16,0	1
	<b>060689</b>	4,8...5,2	15...16	29,8 x 10	22,0	19,0	1
	<b>081745</b>	4,3...5,2	16...18	34,4 x 12	23,0	21,0	1
	<b>080905</b>	4,3...5,2	6...6,5	22,85 x 10	11,5	15,0	1
	<b>060705</b>	4,8...5,2	6...6,55	23 x 10	11,75	14,9	1

E = avec languette pour diamètre variable; F = avec raccord; G = pour gaines annelées

## ENTRETOISES DE TUBES PIVOTANTES 2-VOIES - AVEC SUPPORT TUBE

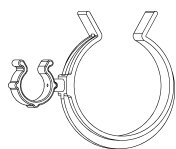

Form 1

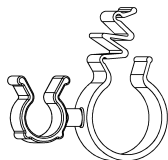

Form 2

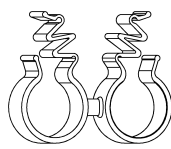

Form 3

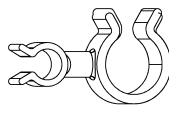

Form 4

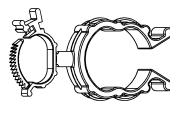

Form 5

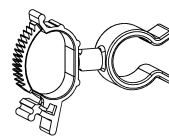

Form 6

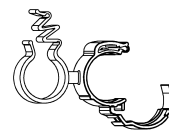

Form 7



Form 8

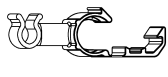

Form 9

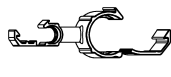

Form 10

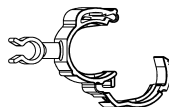

Form 11

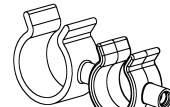

Form 12

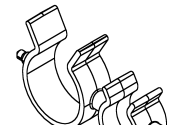

Form 13



Form 14

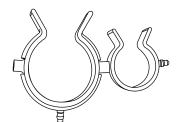

Form 15

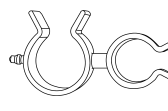

Form 16

Les schémas ne sont donnés qu'à titre d'exemples, seul le dernier plan de chaque pièce est contractuel.

?	REF.	ØD1	ØD2	l x b	h	e1	Form
	060785	4,8...5,2	6...10	37,8 x 10	25,5	17,0	1
	081275	4,3...5,2	8...9	24,85 x 10	13,5	16,0	1
	080999	4,3...5,2	9...9,5	34,15 x 10	15,75	16,0	1
	081032	4,3...5,2	11...13	28,35 x 10	17,5	17,5	1
	060808	4,8...5,2	10...16	44,35 x 10	31,5	20,7	1
	080929	4,3...5,2	11...13	36 35 x 10	17,5	17,5	1
	061016	4,8...5,2	11...13	30,4 x 10	18,5	19,5	1
	081191	4,3...5,2	13...14	30,35 x 10	22,5	18,5	1
	060914	4,8...5,2	20...22	37,5 x 12	28,5	21,5	1
	081053	4,3...5,2	15...16	32,85 x 10	22,5	19,0	1
	061018	4,8...5,2	23,5...25	51,75 x 12	34,5	21,0	1
E	061167	4,8...5,2	23...30	60 x 10	55,0	31,5	1
	081029	4,3...5,2	38...45	63,5 x 10	62,0	30,5	1
	081082	4,3...5,2	20...24,5	36,85 x 12	28,0	21,8	1
	060881	4,8...5,2	18...19	34,8 x 12	16,0	20,2	1
	081180	18...20	4,3...5,2	35,85 x 12	26,0	20,5	1
	060638	4,8...5,2	8...9	27 x 10	14,0	16,0	1
	082513	6...6,5	10...12	32 x 10	16,0	20,5	1
E	082491	6...10	11...13	34,2 x 10	17,5	21,0	1
F	201645	6...6,5	6...6,5	107 x 8	11,5	98,0	1
E	082462	6...6,5	6...10	31 x 10	15,35	18,5	1
	060766	6...6,5	9,5...10,5	29,65 x 10	16,0	18,0	1
	060657	6...6,5	11...13	31,2 x 10	18,0	19,0	1
	080443	6...6,5	11,5...13	31 x 10	17,5	19,25	1
	080445	6...6,5	9,5...10,5	29,5 x 10	16,0	18,25	1
	081205	6...6,5	8...9	25,5 x 8	13,5	19,5	1
	081253	6...6,5	8...9	27,5 x 8	13,5	17,5	1
F	081406	6...6,5	8...9	43 x 8	13,5	33,0	1
	081106	6...6,5	7,8...8,5	25,9 x 12	16,9	16,2	1
	081513	6...6,5	11...13	31 x 10	17,5	19,0	1
	081279	6...6,5	15...16	35,5 x 10	22,5	20,5	1
	081083	6...6,5	6...6,5	25,5 x 8	11,5	16,5	1
	081015	6...6,5	22...24	42 x 12	29,0	24,5	1
	061798	6...6,5	48...53	73,5 x 12	66,5	38,6	1
	081202	6...6,5	38...45	71,7 x 10	62,0	33,0	1
	060910	6...6,5	39...45	65,3 x 10	62,5	33,0	1
F	081229	6...6,5	38...45	81,7 x 10	62,0	47,5	1
	081005	6...6,5	14...15	34 x 10	21,0	20,5	1
	060720	6...6,5	23,5...25	50 x 12	33,5	25,0	1
	155058	6...6,5	11...13	- x 10	17,0	19,8	1
F	080956	6...6,5	19...24,5	46 x 12	28,0	29,1	1
	081277	6...6,5	19...24,5	39,5 x 10	28,0	22,6	1

E = avec languette pour diamètre variable; F = avec raccord; G = pour gaines annelées

## ENTRETOISES DE TUBES PIVOTANTES 2-VOIES - AVEC SUPPORT TUBE

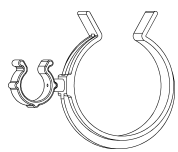

Form 1



Form 2

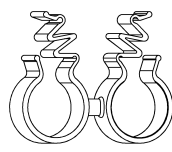

Form 3

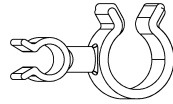

Form 4

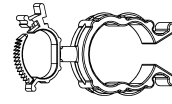

Form 5

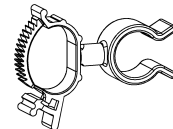

Form 6

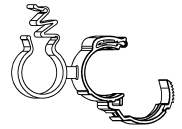

Form 7

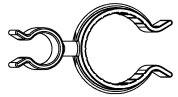

Form 8

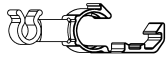

Form 9

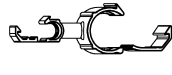

Form 10

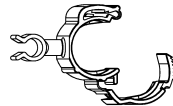

Form 11

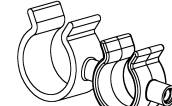

Form 12

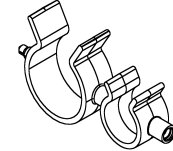

Form 13

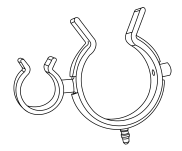

Form 14

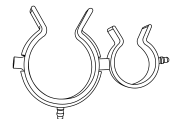

Form 15

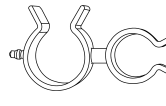

Form 16

Les schémas ne sont donnés qu'à titre d'exemples, seul le dernier plan de chaque pièce est contractuel.

?	REF.	ØD1	ØD2	l x b	h	e1	Form
E	061558	6...6,5	18...20	46,8 x 12	26,0	22,0	1
	081148	6...6,5	18...20	38,5 x 12	26,0	22,0	1
	081414	6...6,5	16...18	36 x 12	23,0	21,5	1
F	081409	6...6,5	15...16	42 x 10	22,5	27,0	1
	060847	6...6,5	14...16	40 x 12	21,0	20,5	1
	081156	6...6,5	13...14	33 x 10	22,5	20,0	1
	081690	6...6,5	23...25	43 x 12	33,5	24,5	1
	081887	6...6,5	13...14	32,2 x 12	23,0	19,9	1
	082028	7,8...8,5	16...18	38,1 x 12	23,0	22,9	1
	018881	7,8...8,5	18...20	38,9 x 12	26,0	21,7	1
E	060722	6...10	23...30	75,1 x 10	55,0	31,0	1
E	061075	6...10	18...20	40,5 x 12	36,0	24,0	1
E	061015	6...10	23,5...25	58,5 x 12	34,5	28,5	1
	060776	6...10	6...10	51,1 x 10	26,0	21,3	1
	081424	7,8...8,5	7,8...8,5	28 x 12	16,9	17,6	1
F	081738	7,8...8,5	14...15	59 x 10	21,25	45,4	1
	081274	7,8...8,5	14...15	59 x 10	21,25	45,4	1
	081592	7,8...8,5	15...16	35,9 x 12	22,5	20,2	1
	081645	7,8...8,5	22...24	44 x 12	29,5	25,9	1
	081198	7,8...8,5	34...36	65,4 x 10	53,5	32,4	1
	082187	7,8...8,5	38...45	66,6 x 10	62,0	34,4	1
F	082443	8...9	8...9	55 x 8	13,5	44,0	1
F	082511	8...9	11...13	45 x 10	17,5	32,0	1
	080900	8...9	14...15	36 x 10	21,25	21,5	1
	081103	7,8...8,5	23...25	50,9 x 12	33,5	24,2	1
	081117	7,8...8,5	23...30	63,25 x 12	53,25	30,75	1
F	082076	8...9	10...12	40,5 x 10	16,0	28,0	1
	082218	8...9	18...20	47 x 12	26,0	29,5	1
	081257	8...9	22...24	44 x 12	29,5	25,5	1
	061349	8...9	22...24	46 x 12	31,0	25,5	1
	081105	7,8...8,5	20...24,5	39,9 x 12	28,25	22,95	1
F	082148	8...9	10...12	46 x 10	16,0	33,5	1
	061496	8...9	18...20	41,5 x 12	25,0	25,0	1
	081111	7,8...8,5	18...20	38,9 x 12	26,0	21,7	1
E	081169	7,8...8,5	16...24	54,6 x 12	44,9	26,5	1
	081431	8...9	16...18	38 x 12	23,0	22,5	1
	060929	8...9	23,5...25	54,3 x 12	34,5	26,0	1
	081340	8...9	15...16	39,5 x 10	22,5	23,5	1
	061705	8...9	30...32	64,3 x 10	55,0	31,5	1
	060831	8...9	14...16	46 x 12	22,0	21,5	1
F	081596	8...9	11...13	48,5 x 10	17,5	35,5	1
F	081670	8...9	11...13	51,5 x 10	17,5	38,5	1

E = avec languette pour diamètre variable; F = avec raccord; G = pour gaines annelées

## ENTRETOISES DE TUBES PIVOTANTES 2-VOIES - AVEC SUPPORT TUBE

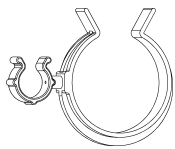

Form 1

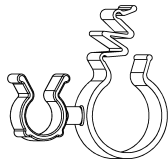

Form 2

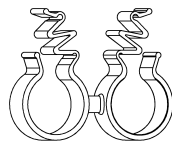

Form 3

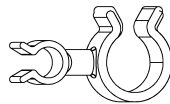

Form 4

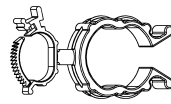

Form 5

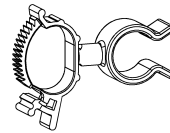

Form 6



Form 7

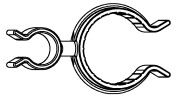

Form 8

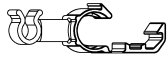

Form 9

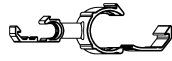

Form 10

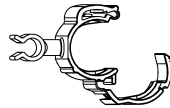

Form 11

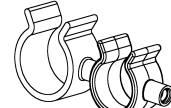

Form 12

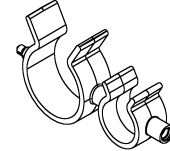

Form 13

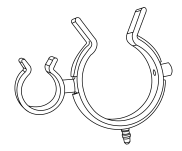

Form 14

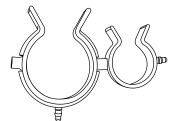

Form 15

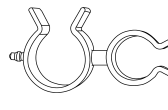

Form 16

Les schémas ne sont donnés qu'à titre d'exemples, seul le dernier plan de chaque pièce est contractuel.

?	REF.	ØD1	ØD2	l x b	h	e1	Form
	081249	8...9	11...13	35 x 10	17,5	22,0	1
	081766	8...9	13...14	37 x 10	22,5	23,0	1
	080985	8...9	11,5...13	33 x 10	17,75	20,25	1
	060942	8...9	11...13	33 x 10	18,0	20,0	1
	082206	8...9	18...20	42,5 x 12	26,0	25,0	1
	082259	8...9	38...45	64 x 10	34,5	35,0	1
	081878	8...9	48...53	74,5 x 12	67,0	39,65	1
	081149	8...9	7,8...8,5	27,9 x 12	16,9	17,2	1
F	081778	8...9	8...9	36 x 8	13,5	25,0	1
	082534	8...9	14...16	46 x 12	21,0	23,5	1
F	201098	8...9	8...9	44,4 x 8	13,5	37,0	1
	080466	8...9	9,5...10,5	31,5 x 10	16,0	19,25	1
	152242	12...14	12...14	30 x 10	19,5	19,0	1
	155059	6...6,5	6...6,5	- x 8	11,5	24,2	1
	080479	8...9	9...9,5	36,5 x 10	15,5	19,0	1
	060696	8...9	9,5...10,5	31,65 x 10	16,0	19,0	1
	080926	8...9	23...25	50,5 x 12	33,5	26,0	1
F	081654	8...9	15...16	53 x 10	22,5	37,0	1
	082501	8...9	34...36	58,5 x 10	47,0	32,0	1
	200811	9...9,5	8...9	33 x 10	15,5	20,5	1
	081076	9...9,5	11...13	40 x 10	17,5	20,5	1
	060761	9...9,5	11...13	42 x 10	20,0	20,0	1
	060763	9...9,5	14...16	51 x 12	22,0	21,5	1
	081844	9...9,5	19...24,5	48,5 x 12	28,25	24,1	1
	061009	9...9,5	23,5...25	68 x 12	33,5	25,5	1
	080499	9,5...10,5	20...24,5	43,5 x 12	28,25	25,05	1
	060648	9,5...10,5	15...16	38,65 x 10	21,5	21,5	1
	080952	9,5...10,5	23...25	54,5 x 12	33,5	26,25	1
	081027	9,5...10,5	18...20	42,5 x 12	26,0	23,75	1
	060649	9,5...10,5	18...20	41,65 x 12	25,0	23,0	1
	061025	9,5...10,5	11...13	43,5 x 10	17,5	21,5	1
	080937	9,5...10,5	10...12	36 x 10	16,0	22,25	1
	060677	9,5...10,5	10,0	36,20 x 10	16,0	21,5	1
	060749	9,5...10,5	39...45	69,5 x 10	61,5	36,3	1
	060781	9,5...10,5	20...22	43,7 x 12	28,0	25,0	1
	060676	9,5...10,5	23,5...25	56 x 12	33,5	26,0	1
	081085	9,5...10,5	13...14	37 x 10	22,5	21,75	1
	081207	9,5...10,5	11...13	35 x 10	17,5	20,75	1
	080901	9,5...10,5	15...16	39,5 x 10	22,5	22,25	1
F	082199	9,5...10,5	15...16	75,3 x 10	22,5	57,25	1
F	082301	9,5...10,5	20...24,5	53,5 x 12	28,25	35,0	1
	081830	9,5...10,5	38...45	64 x 10	53,5	33,75	1

E = avec languette pour diamètre variable; F = avec raccord; G = pour gaines annelées

## ENTRETOISES DE TUBES PIVOTANTES 2-VOIES - AVEC SUPPORT TUBE

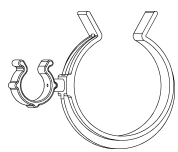

Form 1



Form 2

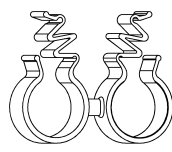

Form 3

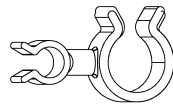

Form 4

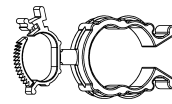

Form 5

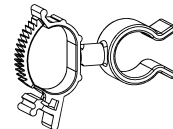

Form 6

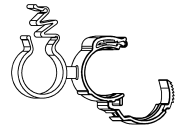

Form 7

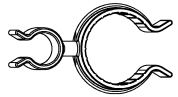

Form 8

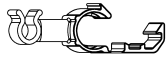

Form 9

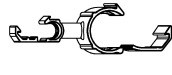

Form 10

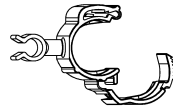

Form 11

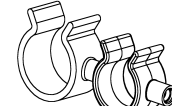

Form 12

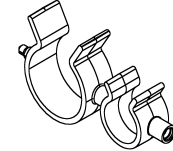

Form 13

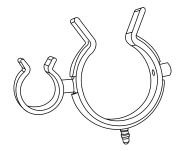

Form 14

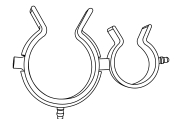

Form 15

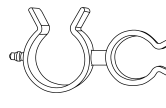

Form 16

Les schémas ne sont donnés qu'à titre d'exemples, seul le dernier plan de chaque pièce est contractuel.

?	REF.	ØD1	ØD2	l x b	h	e1	Form
F	081014	10...12	11...13	61 x 10	17,5	38,5	1
	060710	10...11	11...13	36,5 x 10	17,5	21,5	1
	081119	11...13	11,5...13	37 x 10	17,75	21,75	1
	080476	10...12	11,5...13	38 x 10	17,75	23,25	1
	061707	10...12	13...14	47 x 10	21,0	24,0	1
F	082588	10...12	16...18	59 x 12	23,0	42,0	1
	081098	10...12	14...15	40,5 x 10	21,25	24,5	1
	081430	10...12	16...18	42,5 x 12	23,0	25,5	1
	081591	10...12	34...36	69,5 x 10	53,5	35,0	1
	081042	10...12	23...25	55 x 12	33,5	29,0	1
	081687	10...12	48...53	86,5 x 12	67,0	42,65	1
E	060742	10...16	10...16	63,5 x 10	33,85	28,5	1
	081010	11,5...13	38...45	72,2 x 10	62,0	34,5	1
	080478	11,5...13	15...16	41,5 x 10	22,5	23,0	1
	080924	11,5...13	18...20	44,5 x 12	26,0	24,5	1
	080492	11,5...13	23...25	56,5 x 12	33,5	27,0	1
	081151	11,5...13	13...14	39 x 10	22,5	22,5	1
F	081962	11,5...13	11...13	47 x 10	17,5	31,75	1
	018858	11...13	8...9	51,5 x 10	17,5	38,5	1
	060684	11...13	23,5...25	56,15	33,5	27,15	1
	060619	11...13	20...22	45 x 12	28,0	25,5	1
F	082138	11...13	11...13	43 x 10	17,5	28,0	1
F	081961	11...13	11...13	52 x 10	17,5	37,0	1
F	081208	11...13	15...16	56 x 10	22,5	38,5	1
F	081760	11...13	18...20	50,5 x 12	26,0	31,0	1
	081204	11...13	14...15	39,5 x 10	21,25	23,0	1
F	081647	11,5...13	14...15	58,5 x 10	21,5	41,5	1
	060807	11...13	14...16	48,5 x 12	21,5	23,5	1
	061408	11...13	11...13	42,5 x 10	25,5	21,5	1
	060682	11...13	18...20	42,5 x 12	25,25	24,2	1
	080428	11,5...13	20...24,5	45,5 x 12	28,25	26,05	1
	061432	11...13	26...28	63,5 x 12	42,5	28,2	1
	081370	11...13	34...36	68,5 x 10	53,5	33,5	1
	061327	11...13	39...45	65,5 x 10	53,5	34,0	1
E	081537	11...13	23...30	45,5 x 10	45,75	33,25	1
F	081157	13...14	13...14	47 x 10	22,5	30,0	1
	081494	13...14	22...24	49,5 x 12	29,5	28,0	1
	061477	13...14	14...16	47,5 x 12	21,0	24,0	1
F	082016	13...14	19...24,5	62,5 x 12	28,25	41,6	1
	081650	13...14	34...36	69,7 x 12	53,5	34,4	1
	061000	13...14	13...14	36,3 x 10	20,0	19,0	1
F	081454	13...14	13...14	56 x 10	22,5	39,0	1

E = avec languette pour diamètre variable; F = avec raccord; G = pour gaines annelées



## ENTRETOISES DE TUBES PIVOTANTES 2-VOIES - AVEC SUPPORT TUBE

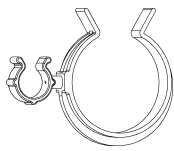

Form 1

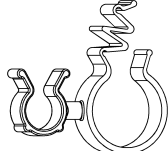

Form 2

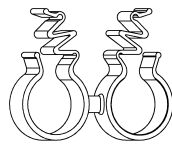

Form 3

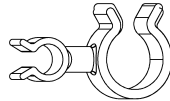

Form 4

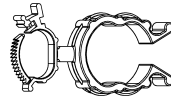

Form 5

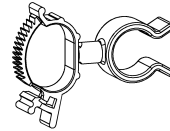

Form 6

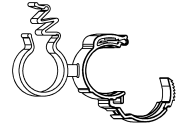

Form 7

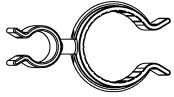

Form 8

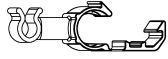

Form 9

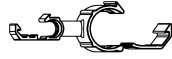

Form 10

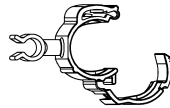

Form 11

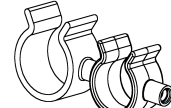

Form 12

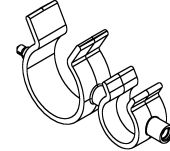

Form 13

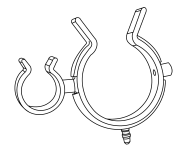

Form 14

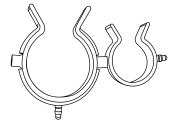

Form 15

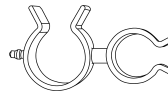

Form 16

Les schémas ne sont donnés qu'à titre d'exemples, seul le dernier plan de chaque pièce est contractuel.

?	REF.	ØD1	ØD2	l x b	h	e1	Form
F	082317	13...14	22...24	73 x 12	29,5	51,5	1
	081797	13...14	48...53	80 x 12	67,0	42,15	1
F	201604	14...15	8...9	52,5 x 10	21,25	38,0	1
	017808	14...15	15...16	45 x 10	22,5	24,5	1
	080923	14...15	15...16	44 x 10	22,5	24,5	1
	060729	14...15	15...16	43 x 10	21,5	24,5	1
	080935	14...15	23...25	59 x 12	33,5	28,5	1
	080906	14...15	19...24,5	48 x 12	28,25	26,6	1
	017143	14...15	19...24,5	47,5 x 12	28,0	26,5	1
F	081438	14...15	38...45	113,5 x 10	62,0	71,0	1
	081099	14...15	38...45	75 x 10	62,0	36,0	1
	081011	14...15	18...20	47 x 12	26,0	26,0	1
F	082395	14...15	38...45	92 x 10	53,5	59,5	1
	081241	14...16	14...15	50,5 x 12	21,0	24,5	1
	080962	14...16	14...16	56,5 x 12	21,0	24,5	1
	060655	14...16	14...16	56,5 x 12	21,0	24,5	1
	060692	14...16	20...22	54 x 12	28,0	27,0	1
	082130	14...16	22...24	58,5 x 12	29,5	28,5	1
	061342	14...16	39...45	90,5 x 12	66,5	36,5	1
	060686	15...16	23,5...25	57,5 x 12	33,5	28,2	1
F	081729	15...16	15...16	52 x 10	22,5	31,0	1
	081808	15...16	16...18	46 x 12	23,0	25,5	1
F	081733	15...16	19...24,5	56 x 12	28,25	33,1	1
	081906	15...16	38...45	74,2 x 10	62,0	37,0	1
	081973	15...16	48...53	90 x 12	67,0	42,65	1
	080978	15...17	19...24,5	57 x 12	28,25	27,8	1
	061494	15,8...17	30...32	99 x 12	53,0	58,5	1
F	082196	15...16	16...18	69,5 x 12	23,0	49,0	1
	081462	16...18	18...20	49 x 12	26,0	27,0	1
	017894	16...18	20...25	50,5 x 12	28,0	28,0	1
	081168	16...18	20...24,5	50 x 12	28,25	28,3	1
	061543	16...18	26...28	72 x 12	40,5	31,5	1
	152326	16...18	28...30	-	-	34,0	1
F	082540	16...18	38...45	87 x 12	53,5	53,5	1
	081618	16...18	38...45	76,7 x 12	62,0	37,0	1
E	081328	16...24	38...45	92,9 x 10	62,0	43,3	1
E	081379	16...24	16...24	80,9 x 10	44,9	36,7	1
	061073	18...20	22...24	54 x 12	29,0	30,0	1
	081097	18...20	38...45	77,2 x 12	62,0	38,5	1
	081013	18...20	22...24	38,5 x 12	29,5	30,0	1
F	081666	18...20	22...24	55 x 12	29,5	46,5	1
	201102	19...24,5	16...18	50 x 30	28,0	28,0	1

E = avec languette pour diamètre variable; F = avec raccord; G = pour gaines annelées

## ENTRETOISES DE TUBES PIVOTANTES 2-VOIES - AVEC SUPPORT TUBE

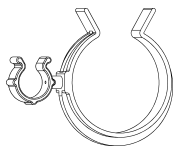

Form 1

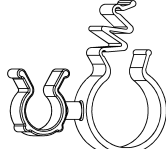

Form 2

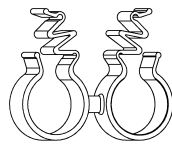

Form 3

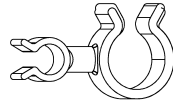

Form 4

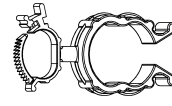

Form 5

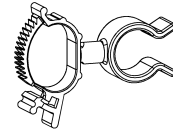

Form 6

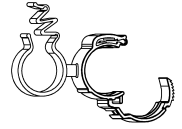

Form 7

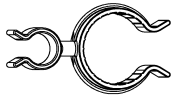

Form 8

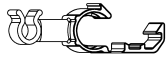

Form 9

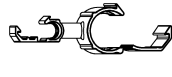

Form 10

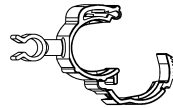

Form 11

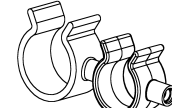

Form 12

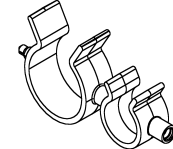

Form 13

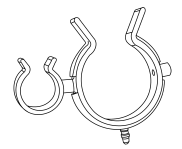

Form 14

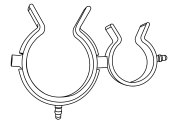

Form 15

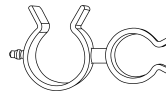

Form 16

Les schémas ne sont donnés qu'à titre d'exemples, seul le dernier plan de chaque pièce est contractuel.

?	REF.	ØD1	ØD2	l x b	h	e1	Form
	080973	19...24,5	22...24	56 x 12	29,5	31,0	1
	080939	19...24,5	23...25	62,5 x 12	33,5	31,1	1
	081325	19...24,5	34...36	77 x 12	53,5	37,5	1
	080940	19...24,5	38...45	78,2 x 12	62,0	39,1	1
	081140	19...24,5	11...13	51 x 12	28,25	25,1	1
	061112	20...22	23,5...25	64,5 x 12	34,5	31,5	1
	061561	20...22	26...28	70,8 x 12	45,0	33,0	1
	060862	20...22	39...45	78,3 x 12	54,0	40,0	1
	201268	22...24	13...14	48,8 x 12	29,5	27,9	1
	081675	22...24	15...16	52 x 12	29,5	28,5	1
	155055	22...24	15...16	-	-	28,5	1
F	082579	22...24	38...45	93 x 12	53,5	56,5	1
E	081995	23...30	23...30	98 x 10	45,75	45,3	1
	060637	23,5...25	23,5...25	74,5 x 12	33,5	34,5	1
	061182	24...25	24...25	80,9 x 10	44,9	36,0	1
	082475	26...28	34...36	91 x 12	53,5	40,5	1
	201059	28...30	7,8...8,5	53,1 x 12	41,0	29,4	1
	081382	38...45	38...45	104,9 x 10	62,0	48,7	1
	081978	38...45	48...53	114,5 x 12	67,0	54,15	1
	061202	39...45	39...45	104,3 x 10	61,8	49,0	1
	208204	4...4,5	9,5...10,5	- x 10	-	17,25	1
	061000	13...14	13...14	-	-	19,3	1
	061073	18...20	22...24	-	-	29...31	1
	060677	9,5...10,5	9,5...11	-	-	20,5...22,5	1
	060747	4...4,8	9,5...10,5	-	-	16,5...17,5	1
	061626	6...6,5	8...9	29,5 x 8	13,5	19,5	1
	061858	8...9	8...9	31,70 x 8	13,5	20,5	1
	132762	4,8...5,2	9,5...11	29,2 x 10	16,0	18,9	1
	060619	11...13	20...22	-	-	24,5...26,5	1
	060638	4,8...5,2	8...9	-	-	16...17	1
	060649	9,5...10,5	18...20	-	-	23,65...24,65	1
	060643	4...4,8	4,8...5,2	-	-	14,15	1
	060648	9,5...10,5	14,5...16	-	-	21...22	1
	060657	6...6,5	11...13	-	-	18...20	1
	060682	11...13	18...20	-	-	23,2...25,2	1
	060696	8...9	9,5...10,5	-	-	18...20	1
	060705	4,8...5,2	6...6,5	-	-	15,0	1
	060710	11...13	11...13	-	-	21,5...23,5	1
	060766	6...6,5	9,5...10,5	-	-	18,15	1
	060781	9,5...10,5	20...22	-	-	23,7...27,2	1
	060942	8...9	11...13	-	-	19...21	1
	061000	13...14	13...14	-	-	19,3	1

E = avec languette pour diamètre variable; F = avec raccord; G = pour gaines annelées

## ENTRETOISES DE TUBES PIVOTANTES 2-VOIES - AVEC SUPPORT TUBE

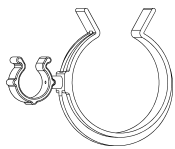

Form 1

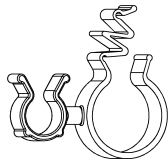

Form 2

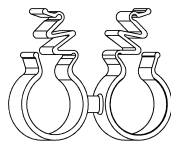

Form 3

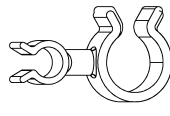

Form 4

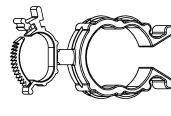

Form 5

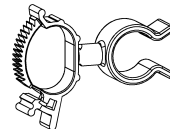

Form 6



Form 7

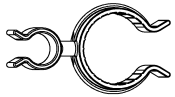

Form 8

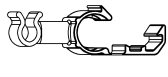

Form 9

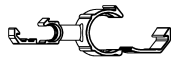

Form 10

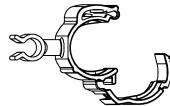

Form 11

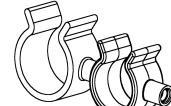

Form 12

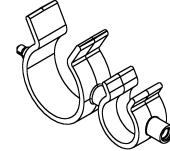

Form 13

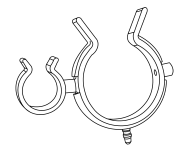

Form 14

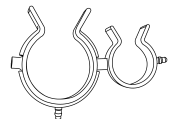

Form 15

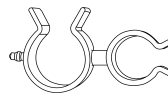

Form 16

Les schémas ne sont donnés qu'à titre d'exemples, seul le dernier plan de chaque pièce est contractuel.

?	REF.	ØD1	ØD2	l x b	h	e1	Form
	061415	13...14	39...45	81,5 x 12	58,0	34,4	1
	061419	13...14	18...20	49,8 x 12	25,0	24,0	1
	061418	11...13	13...14	47,5 x 12	24,2	21,4	1
	081264	7,8...8,5	14,0	34,9 x 12	23,0	20,7	2
	082146	8...9	14,0	38,5 x 10	23,0	24,0	2
	081773	4...4,5	25,0	43 x 12	37,7	25,0	2
	081598	4,3...5,2	25,0	43 x 12	37,7	25,5	2
F	082376	4,3...5,2	25,0	58,5 x 12	37,7	41,0	2
	081957	6...6,5	14,0	34,5 x 10	23,0	21,0	2
	081572	22,0	6...6,5	42 x 12	34,5	24,5	2
	082586	7,8...8,5	25,0	44,9 x 12	37,2	25,7	2
	081265	7,8...8,5	25,0	47,1 x 12	37,7	27,4	2
	082647	8...9	22,0	44 x 12	34,5	25,5	2
	081861	8...9	25,0	47 x 12	37,7	27,0	2
	082056	9,5...10,5	25,0	48,5 x 12	37,7	27,75	2
	081394	10...12	25,0	51,5 x 12	37,7	30,0	2
	081359	11...12	14,0	40,5 x 10	23,0	23,5	2
	081255	11...13	22,0	47,5 x 12	34,5	27,0	2
E	081793	11...13	23...30	82,8 x 10	53,25	49,75	2
F	081796	11...13	25,0	67 x 12	37,7	45,0	2
	081913	15...16	22,0	52 x 12	34,5	28,5	2
	082290	13...14	22,0	49,5 x 12	34,5	28,0	2
	081848	13...14	22,0	48,8 x 12	34,5	27,9	2
	081446	13...14	25,0	52,5 x 12	37,7	29,5	2
	081449	13...14	25,0	51,8 x 12	37,7	29,4	2
F	081787	14,0	11,5...13	64 x 10	23,0	47,0	2
	081786	14,0	14...15	43 x 10	23,0	25,0	2
	082238	14,0	28...30	60 x 12	41,0	32,5	2
F	081648	14...15	25,0	72 x 12	37,7	48,5	2
	081574	14,0	16...18	45 x 12	23,0	26,0	2
	081986	18...20	22,0	55 x 12	34,5	30,0	2
	081594	25,0	18...20	58 x 12	37,7	31,5	2
	190009	19...24,5	25,0	59 x 12	37,7	32,1	2
	081219	19...24,5	22,0	56 x 12	34,5	31,3	2
	201466	22,0	22...24	58,7 x 12	34,5	32,7	2
	081985	22...24	14,0	51 x 12	29,5	29,0	2
	081847	23...25	25,0	70 x 12	37,7	34,0	2
	081885	26...28	26...28	79,5 x 12	40,5	36,0	2
	082439	30...32	22,0	79,3 x 12	53,25	39,05	2
	082500	48...53	14,0	81,5 x 12	67,0	43,15	2
	082692	25,0	22...24	73 x 12	45,0	34,0	2

E = avec languette pour diamètre variable; F = avec raccord; G = pour gaines annelées



## ENTRETOISES DE TUBES PIVOTANTES 2-VOIES - AVEC SUPPORT TUBE

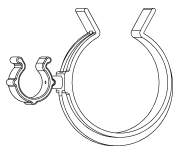

Form 1

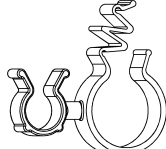

Form 2

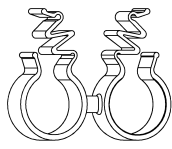

Form 3

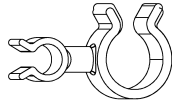

Form 4

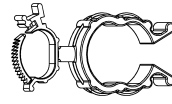

Form 5

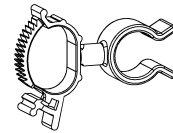

Form 6

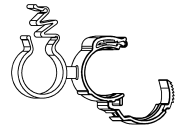

Form 7

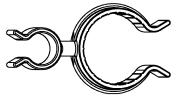

Form 8

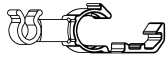

Form 9

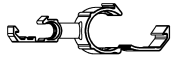

Form 10

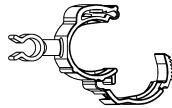

Form 11

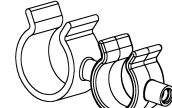

Form 12

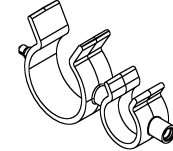

Form 13

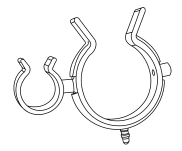

Form 14

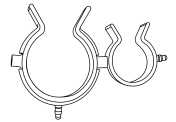

Form 15

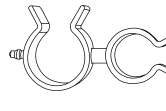

Form 16

Les schémas ne sont donnés qu'à titre d'exemples, seul le dernier plan de chaque pièce est contractuel.

?	REF.	ØD1	ØD2	l x b	h	e1	Form
G	<b>082585</b>	4,5	4,5	28,3 x 10	11,6	17,6	3
	<b>081230</b>	14,0	22,0	51 x 12	34,5	29,0	3
	<b>081172</b>	14,0	25,0	54 x 12	37,7	30,5	3
	<b>081756</b>	22,0	7,8...8,5	44 x 12	34,5	25,9	3
	<b>082508</b>	22,0	22,0	58,7 x 12	34,5	32,7	3
	<b>081638</b>	22,0	25,0	61 x 12	37,2	34,5	3
F	<b>082699</b>	25,0	22,0	80 x 12	37,7	52,5	3
F	<b>081625</b>	25,0	25,0	83 x 12	37,7	54,0	3
	<b>081637</b>	25,0	25,0	64 x 12	37,2	36,0	3
	<b>061651</b>	7,2...7,5	16...18	39,6 x 12	23,0	22,0	4
	<b>081870</b>	4,3...5,2	10...12	30,4 x 10	14,0	18,0	4
	<b>200182</b>	4,3...5,2	13...14	34,35 x 10	17,0	19,0	4
	<b>200184</b>	4,3...5,2	28...30	53,9 x 12	37,0	27,5	4
	<b>082519</b>	4,3...5,2	35...38	59,9 x 12	43,0	30,5	4
	<b>061226</b>	6...10	8...9	37,5 x 10	29,0	20,0	4
	<b>080434</b>	6...6,5	18...20	41,5 x 12	22,0	22,5	4
	<b>081904</b>	7,0	30,0	50,3 x 12	41,5	24,3	4
	<b>081000</b>	7,2...7,5	4,3...5,2	25,95 x 10	10,2	15,6	4
	<b>081130</b>	7,2...7,5	6...6,5	28,6 x 8	10,2	17,1	4
	<b>081597</b>	7,2...7,5	7,8...8,5	29 x 12	16,9	16,8	4
	<b>081458</b>	7,2...7,5	9,5...10,5	32,6 x 10	15,75	18,85	4
	<b>081048</b>	7,2...7,5	14...15	37,1 x 10	21,25	21,1	4
	<b>061559</b>	7,2...7,5	14...16	37,1 x 10	21,25	21,2	4
	<b>190037</b>	7,2...7,5	16...18	39,1 x 12	23,0	22,1	4
	<b>080922</b>	7,2...7,5	22...24	45,1 x 12	29,5	25,1	4
F	<b>081159</b>	7,2...7,5	8...9	46,1 x 8	13,5	33,6	4
F	<b>081886</b>	7,8...8,5	25...27	61,9 x 12	32,0	37,2	4
	<b>082254</b>	8...9	34...36	63,5 x 10	55,0	32,0	4
	<b>080995</b>	10...12	4...4,5	30 x 10	14,0	17,5	4
	<b>081125</b>	10...12	6...6,5	32 x 10	14,0	18,5	4
	<b>081499</b>	10...12	6...6,5	32,5 x 10	14,0	19,0	4
	<b>081669</b>	10...12	7,8...8,5	32,9 x 12	18,0	18,7	4
	<b>082649</b>	10...12	8...9	36,5 x 10	15,0	22,0	4
	<b>081077</b>	10...12	8...9	34 x 10	15,0	19,5	4
F	<b>082650</b>	10...12	8...9	53 x 10	15,0	38,5	4
	<b>080458</b>	10...12	10...12	38,5 x 10	16,0	22,5	4
	<b>080459</b>	10...12	11...13	45,5 x 10	17,5	21,0	4
	<b>082291</b>	10...12	13...14	38,8 x 12	23,0	21,9	4
	<b>081919</b>	10...12	14...15	41 x 10	21,25	23,0	4
	<b>081044</b>	10...12	15...16	39 x 10	22,5	22,5	4
	<b>080996</b>	10...12	19...24,5	46 x 12	28,25	25,3	4

E = avec languette pour diamètre variable; F = avec raccord; G = pour gaines annelées

## ENTRETOISES DE TUBES PIVOTANTES 2-VOIES - AVEC SUPPORT TUBE

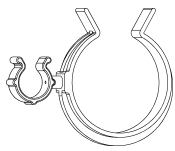

Form 1

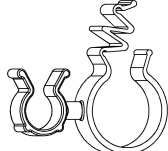

Form 2

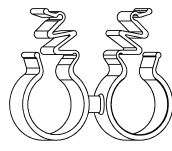

Form 3

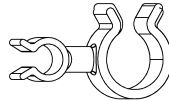

Form 4

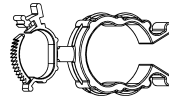

Form 5

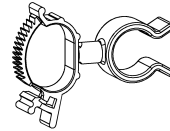

Form 6

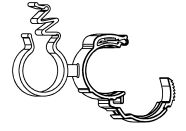

Form 7

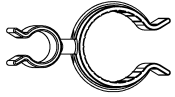

Form 8

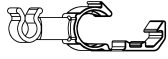

Form 9

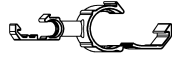

Form 10

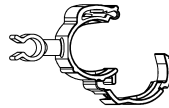

Form 11

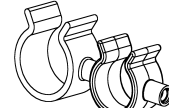

Form 12

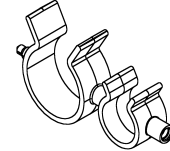

Form 13

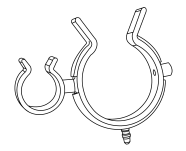

Form 14

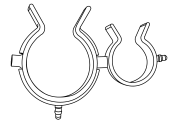

Form 15



Form 16

Les schémas ne sont donnés qu'à titre d'exemples, seul le dernier plan de chaque pièce est contractuel.

?	REF.	ØD1	ØD2	l x b	h	e1	Form
	<b>080993</b>	10...12	39...45	72,5 x 10	62,0	34,0	4
E	<b>061093</b>	10...16	4...4,8	39,85 x 10	35,5	23,5	4
	<b>081129</b>	11,5...13	7,2...7,5	34,6 x 10	17,75	19,6	4
	<b>081153</b>	12...13	4,3...5,2	32,85 x 10	16,0	18,5	4
	<b>081481</b>	12...13	6...6,5	35,5 x 8	16,0	20,0	4
	<b>081641</b>	12...13	7,8...8,5	35,9 x 12	19,0	19,7	4
	<b>082113</b>	12...13	8...9	39,5 x 8	16,0	23,0	4
	<b>082463</b>	12...13	9,5...10,5	39,5 x 10	17,0	21,75	4
F	<b>082212</b>	12...13	13...14	49,5 x 10	22,5	30,0	4
	<b>081133</b>	12...13	14...15	44 x 10	21,25	24,0	4
	<b>081144</b>	12...13	23...25	58,5 x 12	33,5	28,5	4
	<b>081539</b>	13...14	4...4,5	34,5 x 10	17,0	19,0	4
	<b>081469</b>	13...14	7,8...8,5	37,4 x 12	19,5	20,2	4
	<b>081715</b>	13...14	9,5...10,5	41 x 10	17,5	22,25	4
	<b>082111</b>	13...14	13...14	44 x 10	22,5	23,5	4
F	<b>082565</b>	13...14	20...24,5	66,5 x 12	28,25	42,75	4
G	<b>201227</b>	15,5...16,1	18...20	64 x 20	26,0	42,8	4
	<b>060605</b>	16...18	4,8...5,2	36 x 12	20,0	19,5	4
	<b>081288</b>	16...18	6...6,5	39,5 x 12	20,0	22,0	4
F	<b>081139</b>	16...18	6...6,5	46 x 12	20,0	28,5	4
	<b>081220</b>	16...18	7,8...8,5	39,9 x 12	21,0	21,7	4
	<b>081289</b>	16...18	8...9	43,5 x 12	20,0	25,0	4
	<b>060700</b>	16...18	9...9,5	47,5 x 12	20,0	22,5	4
	<b>080450</b>	16...18	9,5...10,5	43,5 x 12	20,0	23,75	4
F	<b>201228</b>	16...18	10...12	52,5 x 12	20,0	32,5	4
	<b>060714</b>	16...18	11...13	44 x 12	20,0	24,5	4
	<b>080449</b>	16...18	11...13	45,5 x 12	20,0	24,5	4
F	<b>081529</b>	16...18	13...14	53,5 x 12	24,0	32,0	4
	<b>061108</b>	16...18	14...16	53 x 12	22,0	25,0	4
	<b>080976</b>	16...18	14...16	54 x 12	22,0	26,0	4
	<b>080496</b>	16...18	14...15	48 x 12	22,0	26,0	4
	<b>081425</b>	16...18	16...18	50 x 12	23,0	27,0	4
	<b>061632</b>	16...18	22...24	55 x 12	29,0	29,0	4
	<b>080992</b>	16...18	22...24	54 x 12	29,5	30,0	4
	<b>061413</b>	16...18	39...45	83 x 12	56,0	37,5	4
	<b>081434</b>	16...24	13...14	59,7 x 12	44,2	29,8	4
E	<b>061130</b>	16...24	4...4,8	51,5 x 12	44,5	28,6	4
	<b>081634</b>	16...24	11...13	58,4 x 10	44,2	28,9	4
	<b>060620</b>	18...20	20...22	55 x 12	28,0	29,0	4
	<b>080444</b>	18...20	19...24,5	55,5 x 12	28,25	28,6	4
	<b>080975</b>	18...20	18...20	54,5 x 12	26,0	28,0	4
	<b>060687</b>	18...20	18...20	53 x 12	25,0	27,7	4

E = avec languette pour diamètre variable; F = avec raccord; G = pour gaines annelées

## ENTRETOISES DE TUBES PIVOTANTES 2-VOIES - AVEC SUPPORT TUBE

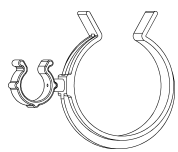

Form 1



Form 2

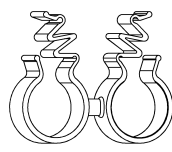

Form 3

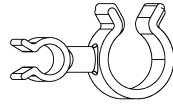

Form 4

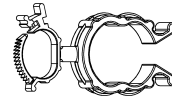

Form 5

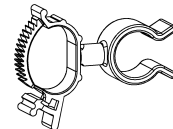

Form 6

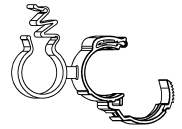

Form 7

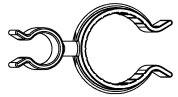

Form 8

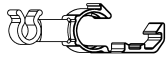

Form 9

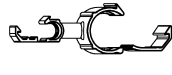

Form 10

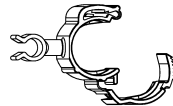

Form 11

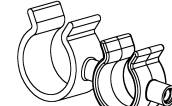

Form 12

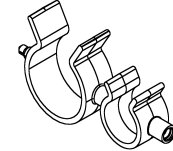

Form 13

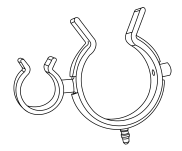

Form 14

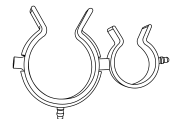

Form 15

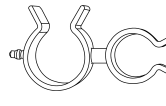

Form 16

Les schémas ne sont donnés qu'à titre d'exemples, seul le dernier plan de chaque pièce est contractuel.

?	REF.	ØD1	ØD2	l x b	h	e1	Form
	080943	18...20	4...4,5	39,5 x 12	22,0	21,5	4
	081281	18...20	4,3...5,2	39,9 x 12	22,0	22,0	4
	060728	18...20	6...6,5	41 x 12	22,0	22,5	4
	080446	18...20	8...9	43,5 x 12	22,0	23,5	4
	060678	18...20	8...9	43 x 12	22,0	23,5	4
	080934	18...20	10...12	48 x 12	22,0	26,5	4
	081012	18...20	15...16	51,5 x 12	23,0	26,5	4
F	082106	18...20	15...16	7,5 x 12	23,0	50,0	4
F	082295	18...20	18...20	7,1 x 12	26,0	44,5	4
	061012	20...22	13...14	51,1 x 10	26,6	26,9	4
	061145	20...22	20...22	58 x 12	28,0	30,0	4
	082078	22...23	8...9	47,4 x 10	35,5	25,5	4
	082444	22...30	8...9	58 x 16	-	29,5	4
	061187	23...30	39...45	104,8 x 10	61,5	44,0	4
	081515	25,0	25...27	71 x 12	39,2	37,0	4
	081327	25...27	4,3...5,2	48,85 x 12	32,0	26,0	4
	082042	25...27	8...9	55,5 x 12	32,0	30,5	4
F	082457	25...27	8...9	60 x 12	32,0	35,0	4
	200597	25...27	9,5...10,5	55,5 x 12	32,0	29,25	4
	081602	25...27	11,5...13	57,25 x 12	32,0	30,25	4
	081672	25...27	15...16	68 x 12	32,0	38,0	4
F	200539	25...27	16...18	72 x 12	32,0	42,5	4
	081845	25...27	22...24	68 x 12	32,0	35,5	4
	082396	25...27	38...45	92,5 x 12	54,5	49,5	4
	061681	26...28	8...9	57,5 x 12	47,5	29,0	4
	081017	28...30	4...4,5	53,5 x 12	37,0	26,7	4
	080481	28...30	6...6,5	55,5 x 12	37,0	28,0	4
	081937	28...30	7,8...8,5	57,6 x 12	37,0	29,4	4
	080483	28...30	8...9	57,5 x 12	37,0	29,0	4
	081142	28...30	10...12	62 x 12	37,0	32,0	4
	081137	28...30	11...13	62,5 x 12	37,0	30,5	4
	081644	28...30	13...14	63 x 12	37,0	31,5	4
	081331	28...30	14,0	-	-	32,5	4
	081004	28...30	15...16	65,5 x 12	37,0	32,0	4
	081671	28...30	19...24,5	69,5 x 30	37,0	34,5	4
	080944	28...30	19...24,5	69,5 x 12	37,0	34,0	4
F	082189	28...30	19...24,5	79,5 x 12	37,0	44,5	4
	082029	28...30	18...20	68,5 x 12	37,0	33,5	4
	060824	29...33	6...6,5	55,7 x 12	36,6	28,0	4
	060826	29...33	8...9	57 x 12	36,6	29,0	4
	061161	29...33	10...11	61,2 x 12	36,6	30,0	4
	061290	29...33	13...14	62,4 x 12	36,6	31,8	4

E = avec languette pour diamètre variable; F = avec raccord; G = pour gaines annelées

## ENTRETOISES DE TUBES PIVOTANTES 2-VOIES - AVEC SUPPORT TUBE

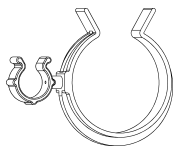

Form 1

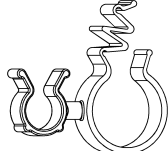

Form 2

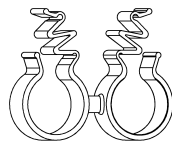

Form 3

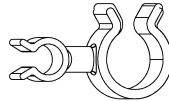

Form 4

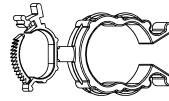

Form 5

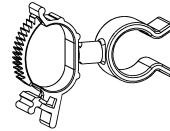

Form 6

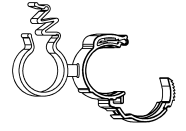

Form 7

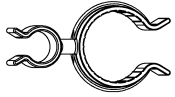

Form 8

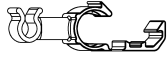

Form 9

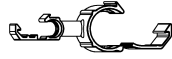

Form 10

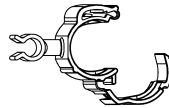

Form 11

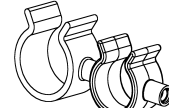

Form 12

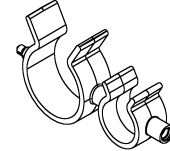

Form 13

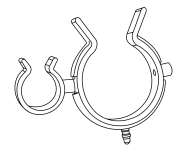

Form 14

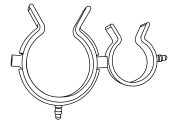

Form 15

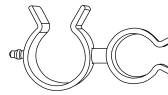

Form 16

Les schémas ne sont donnés qu'à titre d'exemples, seul le dernier plan de chaque pièce est contractuel.

?	REF.	ØD1	ØD2	l x b	h	e1	Form
	060758	29...33	18...20	66,5 x 12	36,6	32,5	4
	060724	29...33	20...22	69,7 x 12	36,6	34,4	4
	060950	29...33	23,5...25	80 x 12	36,6	36,0	4
	081197	34...36	11...13	75 x 10	55,0	33,5	4
	081470	34...36	15...16	71,5 x 10	55,0	35,0	4
	081514	34...36	18...20	74,5 x 12	55,0	36,5	4
	081075	35...38	4...4,8	59,5 x 12	43,0	30,0	4
	081443	35...38	6...6,5	61,5 x 12	43,0	31,0	4
	081971	35...38	7,8...8,5	63,6 x 12	43,0	32,4	4
	081551	35...38	8...9	63,5 x 12	43,0	32,0	4
	081268	35...38	10...12	68 x 12	43,0	35,0	4
	081321	35...38	13...14	69 x 12	43,0	34,5	4
	082641	35...38	15...16	71,5 x 12	43,0	35,0	4
	081928	35...38	18...20	74,5 x 12	43,0	36,5	4
	081662	35...38	26...28	89,5 x 12	43,0	40,5	4
F	081595	35...38	38...45	118,7 x 12	62,0	63,0	4
	081464	38...45	8...9	72 x 10	56,2	35,5	4
	080997	38...45	4...4,5	68 x 10	56,2	33,5	4
	080954	38...45	6...6,5	70 x 10	56,2	34,5	4
	061069	39...45	8...9	72 x 10	55,8	35,5	4
	080972	38...45	10...12	76,5 x 10	56,2	38,5	4
	061193	39...45	15...16	78,5 x 10	55,8	38,0	4
	080994	38...45	15...16	80 x 10	56,2	38,5	4
	081222	38...45	19...24,5	84 x 12	56,2	40,6	4
	061244	39...45	23,5...25	95 x 10	55,8	42,5	4
F	081160	7,5	13,0	42,6 x 10	22,5	27,1	4
	060678	8...9	18...20	43 x 12	24,0	24,5	4
	060826	8...9	29...31	58,5 x 12	39,0	32,0	4
	060758	18...20	29...33	67,5 x 12	42,0	37,7	4
G	082643	7,2...7,5	9,6...10,2	32 x 15	14,4	18,05	5
	081332	10,0	22,0	85 x 14	-	38,3	5
G	082487	12...13	6,8...7,4	35,8 x 10	16,0	19,55	5
	081480	10...14	22...30	73,5 x 16	-	32,0	5
	190003	13...14	25,0	56,5 x 12	37,7	30,0	5
	081331	14,0	28...30	64,5 x 12	37,0	32,5	5
G	200782	15,5...16,1	22,0	55 x 20	34,5	30,0	5
	061309	16...18	45...95	132 x 12	40...68	-	5
	060857	16...18	48...80	83 x 13	113,0	-	5
G	201408	20,6...21,4	19...24,5	54,5 x 20	-	30,3	5
	201467	22,0	28...30	72,2 x 12	40,0	36,2	5
	081563	35...38	14,0	70,5 x 12	43,0	35,5	5

E = avec languette pour diamètre variable; F = avec raccord; G = pour gaines annelées

## ENTRETOISES DE TUBES PIVOTANTES 2-VOIES - AVEC SUPPORT TUBE

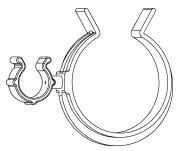

Form 1

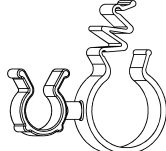

Form 2

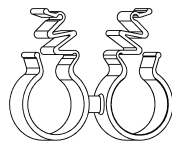

Form 3

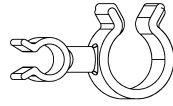

Form 4

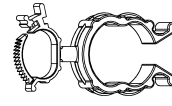

Form 5

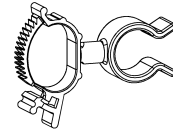

Form 6

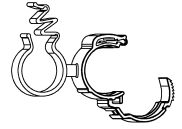

Form 7

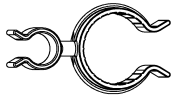

Form 8

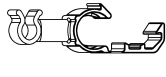

Form 9

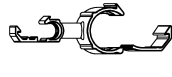

Form 10

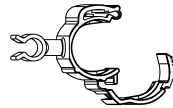

Form 11

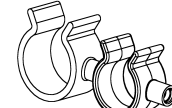

Form 12

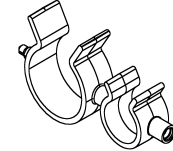

Form 13

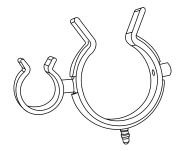

Form 14

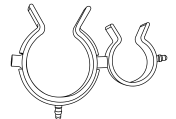

Form 15

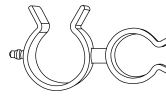

Form 16

Les schémas ne sont donnés qu'à titre d'exemples, seul le dernier plan de chaque pièce est contractuel.

?	REF.	ØD1	ØD2	l x b	h	e1	Form
G	<b>081837</b>	6,8...7,4	4,3...5,2	27,2 x 10	11,6	15,55	6
	<b>200230</b>	7,8...8,5	16...22	32,9 x 12	45,5	22...25,1	6
	<b>081788</b>	9,5...10,5	17,0	42,1 x 20	29,0	25,05	6
G	<b>200245</b>	9,6...10,2	11,5...13	36,9 x 15	17,75	22,2	6
	<b>190011</b>	10...14	6...6,5	33,5 x 9,2	34,4	17...19	6
	<b>082459</b>	10...14	7,2...7,5	36,6 x 9,2	34,4	17...19	6
	<b>082446</b>	10...14	13...14	46,5 x 10	34,4	22,8...24,8	6
	<b>081693</b>	10...14	22...24	52 x 12	34,4	27...29	6
G	<b>082058</b>	12,6...13,2	18...20	44,9 x 15	26,0	24,85	6
G	<b>082036</b>	15,5...16,1	8...9	36,5 x 20	22,4	21,8	6
	<b>082672</b>	16...22	4,3...5,2	38,9 x 10	45,5	18,9...22,9	6
	<b>190012</b>	16...22	6...10	40 x 10	45,5	24,4...27,4	6
	<b>082552</b>	16...22	8...9	42,5 x 9,2	45,5	21,4...24,4	6
	<b>082575</b>	16...22	10...12	47 x 10	45,5	24,4...27,4	6
F	<b>082437</b>	22,0	10...12	107,8 x 12	34,5	87,0	6
	<b>201511</b>	16...22	11...13	46 x 10	45,5	22,9...25,9	6
	<b>081653</b>	16...22	14...15	43,5 x 10	45,5	26,4...29,4	6
	<b>200238</b>	16...22	16...18	45,5 x 12	45,50	27,4...30,4	6
	<b>081528</b>	16...22	18...20	53,5 x 12	45,5	25,9...28,9	6
E	<b>201314</b>	20,6...21,4	6...10	46 x 20	-	26,0	6
	<b>082543</b>	23,1...23,3	11,5...13	50,8 x 20	-	29,25	6
	<b>082645</b>	23,1...23,3	22...24	61,3 x 20	-	34,5	6
	<b>082623</b>	25,1...25,9	7,8...8,5	46,4 x 20	-	25,95	6
	<b>200397</b>	25,1...25,9	11,5...13	52 x 20	-	29,0	6
G	<b>082554</b>	25,1...25,9	9,5...10,5	49,8 x 20	-	28,0	6
G	<b>082436</b>	25,1...25,9	14...15	54,3 x 20	-	30,25	6
	<b>082705</b>	25,1...25,9	16...18	56,3 x 20	-	31,25	6
	<b>081676</b>	33...35	10...12	64,5 x 16	49,0	35,5	6
F	<b>081708</b>	33...35	34...36	114 x 16	53,5	64,5	6
E	<b>082402</b>	33...35	23...30	95,5 x 16	53,25	46,05	6
G	<b>082496</b>	9,6...10,2	20,6...21,4	45,9 x 20	-	26,45	7
G	<b>082572</b>	9,6...10,2	22,0	47,4 x 15	34,5	27,45	7
	<b>200074</b>	10...14	33...35	68 x 16	49,0	-	7
G	<b>082393</b>	15,5...16,1	25,0	53,5 x 20	34,5	30,3	7
	<b>082405</b>	25,1...25,9	22,0	62,30 x 20	-	34,25	7
	<b>082662</b>	16...22	14,0	49,5 x 10	45,5	24,9...27,9	7
	<b>081724</b>	16...22	22,0	59 x 12	45,5	30,4...33,4	7
	<b>082448</b>	16...22	33...35	75 x 16	49,0	37,4...40,4	7
	<b>081819</b>	17,0	33...35	70,6 x 20	49,0	38,3	7
	<b>200562</b>	25,1...25,9	22,0	62,5 x 20	-	34,25	7

E = avec languette pour diamètre variable; F = avec raccord; G = pour gaines annelées



## ENTRETOISES DE TUBES PIVOTANTES 2-VOIES - AVEC SUPPORT TUBE

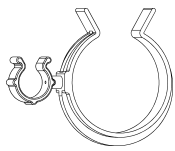

Form 1

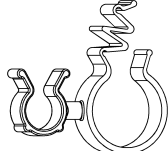

Form 2

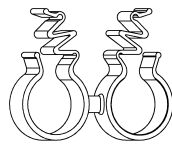

Form 3

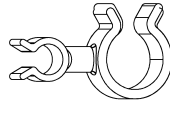

Form 4

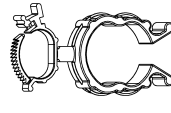

Form 5

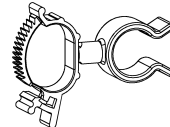

Form 6

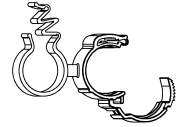

Form 7

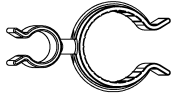

Form 8

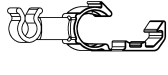

Form 9

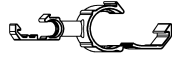

Form 10

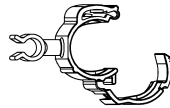

Form 11

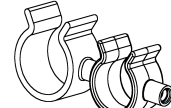

Form 12

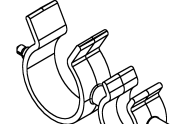

Form 13

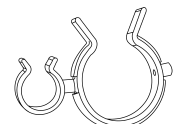

Form 14

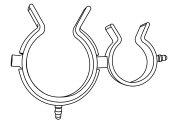

Form 15

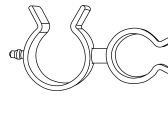

Form 16

Les schémas ne sont donnés qu'à titre d'exemples, seul le dernier plan de chaque pièce est contractuel.

?	REF.	ØD1	ØD2	l x b	h	e1	Form
	<b>155053</b>	6,0	15,5	-	-	-	8
F	<b>200233</b>	6...6,5	10...12	41,5 x 10	14,0	25,5	8
F	<b>081518</b>	7,2...7,5	28...30	74,6 x 12	37,0	45,1	8
	<b>081194</b>	7,2...7,5	28...30	58,1 x 12	37,0	28,6	8
F	<b>081562</b>	7,2...7,5	25...27	70,1 x 12	32,0	43,6	8
	<b>081126</b>	7,2...7,5	18...20	44,6 x 12	22,0	23,1	8
	<b>081459</b>	7,2...7,5	13...14	39,6 x 10	17,0	20,6	8
	<b>081079</b>	7,2...7,5	10...12	35,1 x 10	14,0	19,1	8
G	<b>200860</b>	9,6...10,2	16...18	42,95 x 15	20,0	22,95	8
	<b>081522</b>	10...12	18...20	48 x 12	22,0	25,0	8
	<b>080463</b>	10...12	16...18	46 x 12	20,0	24,0	8
	<b>081143</b>	10...12	12...13	42 x 10	16,0	22,0	8
	<b>081622</b>	10...12	10...12	39 x 10	14,0	21,0	8
	<b>081606</b>	10...12	13...14	43,5 x 10	17	22,5	8
	<b>081330</b>	10...12	25...27	58 x 12	32,0	29,5	8
E	<b>081145</b>	12...13	16...24	62,9 x 10	44,2	29,9	8
	<b>081373</b>	12...13	18...20	51 x 12	22,0	26,0	8
	<b>081224</b>	12...13	28...30	65 x 12	37,0	31,5	8
	<b>081540</b>	13...14	25...27	62,5 x 12	32,0	31,0	8
	<b>081504</b>	13...14	28...30	66,5 x 12	37	32,0	8
F	<b>080951</b>	16...18	16...18	60 x 12	20,0	34,0	8
	<b>081201</b>	16...18	38...45	84 x 12	56,2	40,0	8
	<b>080451</b>	16...18	18...20	55 x 12	22,0	28,0	8
	<b>060704</b>	16...18	18...20	54 x 12	22,0	27,0	8
	<b>060949</b>	16...18	29...33	68,5 x 12	36,6	32,5	8
	<b>081450</b>	16...18	28...30	69 x 12	37	33,5	8
	<b>082690</b>	16...18	35...38	75,5 x 12	43,0	36,5	8
	<b>081465</b>	18...20	25...27	67,5 x 12	32,0	33,5	8
F	<b>082570</b>	25...27	25,1...25,9	- x 20	-	43,75	8
F	<b>082657</b>	25...27	25...27	100,5 x 12	32,0	61,5	8
	<b>081576</b>	25...27	28...30	81,5 x 12	37,0	39,0	8
	<b>081399</b>	25...27	38...45	96 x 12	56,2	45,5	8
	<b>200951</b>	60...65	10...12	103,5 x 15	74,0	49,5	8
G	<b>190010</b>	6,8...7,4	6...6,5	25,8 x 10	11.50,0	16,05	9
G	<b>081707</b>	6,8...7,4	7,8...8,5	27,9 x 10	16,9	17,45	9
G	<b>081659</b>	6,8...7,4	8...9	27,8 x 10	13,5	17,05	9
G	<b>081636</b>	6,8...7,4	11...13	31,3 x 10	17,5	18,55	9
G	<b>081726</b>	6,8...7,4	19...24,5	39,8 x 12	28,25	22,85	9
G	<b>081732</b>	9,6...10,2	4,3...5,2	27,3 x 15	14,4	16,95	9
F,G	<b>200110</b>	9,6...10,2	4,3...5,2	28,25 x 15	15,0	17,95	9
G	<b>081714</b>	9,6...10,2	15...16	38,9 x 15	22,5	21,45	9

E = avec languette pour diamètre variable; F = avec raccord; G = pour gaines annelées

## ENTRETOISES DE TUBES PIVOTANTES 2-VOIES - AVEC SUPPORT TUBE

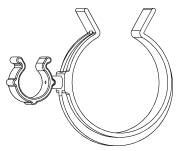

Form 1

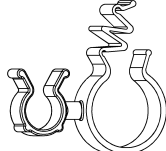

Form 2

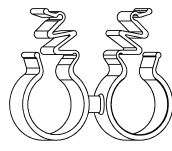

Form 3

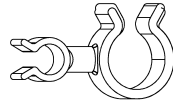

Form 4

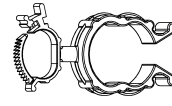

Form 5

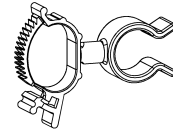

Form 6

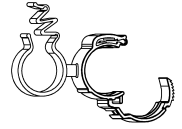

Form 7

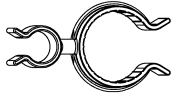

Form 8

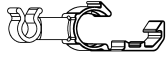

Form 9

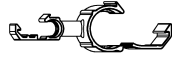

Form 10

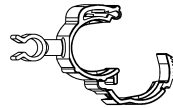

Form 11

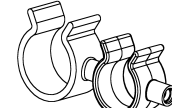

Form 12

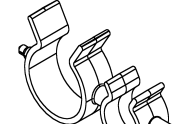

Form 13

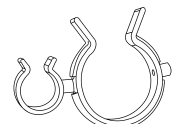

Form 14

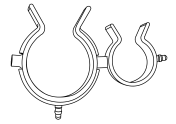

Form 15

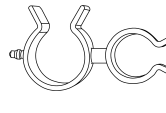

Form 16

Les schémas ne sont donnés qu'à titre d'exemples, seul le dernier plan de chaque pièce est contractuel.

?	REF.	ØD1	ØD2	l x b	h	e1	Form
G	<b>201512</b>	9,6...10,2	18...20	46,9 x 15	22,0	25,45	9
G	<b>082479</b>	12,6...13,2	7,8...8,5	32,9 x 15	19,0	19,7	9
G	<b>200127</b>	12,6...13,2	4,3...5,2	29,85 x 15	19,0	18,5	9
G	<b>082559</b>	12,6...13,2	10...12	38,4 x 15	19,0	23,35	9
G	<b>082619</b>	15,5...16,1	16...18	46,3 x 20	23,0	27,0	9
G	<b>082529</b>	25,1...25,9	22...24	- x 20	-	34,25	9
	<b>206956</b>	33...38	13...14	62,12 x 16	-	34,75	9
G	<b>081992</b>	6,8...7,4	16...22	42,8 x 10	45,5	-	10
G	<b>082482</b>	6,8...7,4	15,5...16,1	37 x 20	22,4	22,35	10
G	<b>082017</b>	6,8...7,4	17,0	38,4 x 20	29,0	22,85	10
G	<b>201356</b>	10...14	9,6...10,2	38,9 x 15	34,4	20,25...23,25	10
	<b>200530</b>	10...14	10...14	43,5 x 9,2	34,4	20...24	10
	<b>200033</b>	10...14	16...22	50,5 x 9,2	45,5	23,2...28,2	10
G	<b>200320</b>	12,6...13,2	9,6...10,2	37,3 x 15	18,2	22,3	10
	<b>201446</b>	16...22	10...14	50,5 x 9,2	45,5	23,2...28,2	10
G	<b>082033</b>	20,6...21,4	33...35	73,5 x 20	49,0	39,0	10
G	<b>200385</b>	20,6...21,4	12,5...13,2	47,5 x 20	-	27,0	10
	<b>201164</b>	22...24	19...21	- x 20	-	33,6	10
	<b>201398</b>	33...38	10...14	- x 16	-	-	10
	<b>200561</b>	33...38	17,0	- x 20	-	38,3	10
	<b>202284</b>	33...38	22...24	- x 20	-	41,3	10
G	<b>200781</b>	20,6...21,4	7,2...7,5	43,6 x 20	-	24,1	11
G	<b>201717</b>	20,6...21,4	35...38	77 x 20	43,0	38,5	11
F,G	<b>201718</b>	20,6...21,4	25...27	73,5 x 20	32,0	41,5	11
	<b>060662</b>	18...20	14...16	50 x 12	25,25	26,0	12
	<b>061157</b>	18...20	23...25	60,5 x 12	33,0	30...32	12
	<b>060945</b>	23...25	14...16	65 x 12	33,5	26...31	13
	<b>060690</b>	9,0	9,0	45,5 x 10	16,0	18...20	13
	<b>060764</b>	18...20	39...45	75 x 12	61,5	36,6...40,6	14
	<b>060868</b>	23...25	39...45	88 x 12	-	40...42	15
	<b>060685</b>	23...25	18...20	65,85 x 12	-	29,5	16

E = avec languette pour diamètre variable; F = avec raccord; G = pour Gaines annelées

## ENTRETOISES DE TUBES PIVOTANTES 2-VOIES - AVEC SUPPORT TUBE ET LANIERE

**MATIERES:**

Polyamide, résines acétales

**COULEURS:**

Noir (autres couleurs, nous consulter)

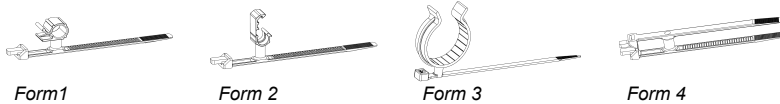
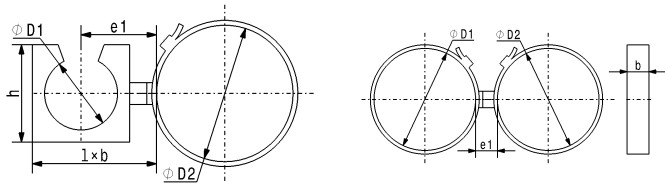

Les schémas ne sont donnés qu'à titre d'exemples, seul le dernier plan de chaque pièce est contractuel.

Lanière associée à un support de tube avec liaison pivotante.



**PARTICULARITÉ(S) DE LA PIÈCE**

Voir correspondance des signes page 4  
Dimensions en mm.

*Échantillons disponibles sur demande*

?	REF.	ØD1	ØD2	l x b	h	e1	Form
	081047	4,3...5,2	8...20	17,35 x 10	9,4	14,0	1
	060828	6...6,5	8...20	18,5 x 8	11,75	14,0	1
	081987	6...6,5	8...20	20 x 8	11,5	15,5	1
	081506	7,8...8,5	8...20	20,4 x 12	16,9	15,2	1
	080472	8...9	8...20	20,5 x 8	13,5	15,0	1
	080456	9,5...10,5	8...20	23 x 10	16,0	17,25	1
	081007	10...12	8...20	25 x 10	16,0	18,0	1
	060698	11...13	8...20	25,5 x 10	18,5	20,0	1
	081231	11...13	8...20	26 x 10	17,75	18,0	1
	081691	15...16	8...20	28,5 x 10	22,5	18,0	1
	081530	16...18	8...20	30,5 x 12	23,0	20,5	1
	081849	18...20	8...20	31,5 x 12	26,0	19,5	1
	081531	22...24	8...20	36,5 x 12	29,5	23,5	1
	082550	28...30	8...20	45,3 x 12	40,8	27,0	1
	201022	28...30	8...33	45,3 x 12	40,8	27,0	1
	201024	34...36	8...20	53 x 10	47,0	30,0	1
	082293	4,3...5,2	8...33	16,25 x 10	9,4	12,75	1
	081043	4,3...5,2	8...33	17,5 x 10	9,4	14,0	1
F	081132	6,0	8...33	26,5 x 8	11,5	22,0	1
	201377	6...6,5	8...33	20 x 8	11,5	15,5	1
	082660	6...10	8...33	23,75 x 10	15,35	16,25	1
	082646	7,8...8,5	8...33	19,15 x 12	16,9	13,95	1
	081217	7,8...8,5	8...33	20,4 x 12	16,9	15,2	1
	082294	8...9	8...33	18,75 x 8	13,5	17,25	1
	082061	8...9	8...33	20 x 8	13,5	18,5	1
	082520	9,5...10,5	8...33	22,75	16,0	16,0	1
F	081046	8...20	8...33	39,5 x 12	26,0	27,5	1
	080497	9,5...10,5	8...33	24 x 10	16,0	17,25	1
	082281	11...13	8...33	24,5 x 10	17,75	16,75	1
	061414	11...13	8...33	28,5	18,5	21,0	1
	080909	14...15	8...33	29 x 10	21,0	19,5	1
	082516	14...15	8...33	27,5 x 10	21,0	18,25	1
	082282	16...18	8...33	29 x 12	23,0	19,25	1
	081536	16...18	8...33	30,5 x 12	23,0	20,5	1
F	201172	16...18	8...33	45,75 x 12	23,0	35,75	1
F	082486	18...20	8...33	48,5 x 12	26,0	36,5	1
F	081566	19...24,5	8...33	49,1 x 12	28,0	37,1	1
	082280	22...24	8...33	35,5 x 12	29,5	22,25	1
	081190	22...24	8...33	36,5 x 12	29,5	23,5	1
	061275	6...6,5	8...50	18,8 x 8	11,75	14,0	1
	081124	6...6,5	8...50	18,5 x 8	11,5	14,0	1
	060787	8...9	8...50	20,5 x 8	13,5	15,0	1

F = avec raccord  
G = pour gaines annelées

## ENTRETOISES DE TUBES PIVOTANTES 2-VOIES - AVEC SUPPORT TUBE ET LANIERE



Form 1



Form 2



Form 3



Form 4

Les schémas ne sont donnés qu'à titre d'exemples, seul le dernier plan de chaque pièce est contractuel.

?	REF.	ØD1	ØD2	l x b	h	e1	Form
	081291	8...9	8...50	20,5 x 8	13,5	15,0	1
	081080	10...12	8...50	25 x 10	16,0	18,0	1
	061430	10...12	8...50	25 x 10	16,0	18,0	1
	081725	11...13	8...50	24 x 10	17,5	16,5	1
F	200116	11,5...13	8...33	42,5 x 10	17,75	34,75	1
	082021	13...14	8...50	26 x 10	22,5	17,5	1
	061169	15...16	8...50	27,5 x 10	21,5	18,0	1
	061125	23...25	8...50	43,3 x 12	33,5	22,0	1
F	082542	19...24,5	8...50	43 x 12	28,0	30,75	1
	061299	18...20	8...50	30,5 x 12	25,0	19,5	1
	081037	18...20	8...50	31,5 x 12	26,0	19,5	1
	081154	19...24,5	8...50	32,35 x 12	28,0	20,1	1
	061037	20...22	8...50	32,5 x 12	38,0	20,5	1
	082157	38...45	8...50	53 x 10	53,5	29,5	1
	081590	38...45	8...50	59 x 10	62,0	29,5	1
	080471	6...6,5	8...75	18,5 x 8	11,5	14,0	1
	081093	6...10	8...75	31,5 x 10	25,5	16,0	1
	080482	8...9	8...75	20,5 x 8	13,5	15,0	1
	080945	9...9,5	8...75	29,5 x 10	16,0	15,0	1
	081138	11...13	8...75	24 x 10	17,5	16,5	1
	081868	15...16	8...75	28,5 x 10	22,5	18,0	1
	061114	15...16	8...75	27,5 x 10	21,5	18,0	1
	080953	11,5...13	8...33	26 x 10	18,0	18,0	1
	080477	6...6,5	10...52	18,5 x 8	11,5	14,0	1
	080487	8...9	10...52	20,5 x 8	13,5	15,0	1
	081051	4...4,5	10...52	16,5 x 8	9,5	13,0	1
	081354	4,3...5,2	10...52	16,9 x 10	9,4	13,5	1
	082400	7,8...8,5	10...52	20,6 x 10	16,9	15,4	1
	081284	10...12	10...52	25 x 10	16,0	18,0	1
	081104	11...13	10...52	23,7 x 10	17,5	16,5	1
	080927	11...13	10...52	32 x 10	17,5	16,5	1
	081363	13...14	10...52	26 x 10	22,5	17,5	1
	080983	14...16	10...52	35 x 12	21,0	18,0	1
	081295	19...24,5	10...52	32,35 x 12	28,25	20,75	1
	082165	23...30	10...52	55,8 x 10	53,25	28,55	1
	082394	38...45	10...52	53 x 10	53,5	29,5	1
	081704	14...15	30...80	25 x 12,5	21,0	16,0	1
	082604	16...18	30...80	27 x 12	23,0	17,0	1
	081179	4...4,5	46...95	16,5 x 8	9,5	13,0	1
	061368	13...14	46...95	26 x 10	20,0	17,5	1
	081259	23...30	46...95	55,8 x 10	53,25	28,55	1
	081120	11...13	46...95	24 x 10	17,5	16,5	1
	081035	10...12	46...95	25 x 10	16,0	18,0	1
	080486	6...6,5	46...75	18,5 x 8	11,5	14,0	1
	080465	10...12	46...75	25 x 10	16,0	18,0	1
	081127	13...14	46...75	26 x 10	22,5	17,5	1
	081287	15...16	46...75	28,5 x 10	22,5	18,0	1
	081128	18...20	46...75	31,5 x 12	26,0	19,5	1
	081136	19...24,5	46...75	32,35 x 12	28,25	20,1	1
	081366	23...30	46...75	54,3 x 10	53,25	28,55	1
	081228	38...45	46...75	59 x 10	62,0	29,5	1
	081929	7,8...8,5	46...95	20,6 x 10	16,8	15,4	1
	081036	14...16	46...95	35 x 12	21,0	18,0	1
	190006	7,8...8,5	46...95	20,6 x 10	16,9	15,4	1
	082050	15...16	46...95	28,5 x 10	22,5	18,0	1
	081966	19...24,5	46...95	32,75 x 12	28,25	20,5	1
	060827	6...6,5	48...80	18,5 x 8	11,5	14,0	1
	060823	8...9	48...80	20,5 x 8	13,5	15,0	1

F = avec raccord  
 G = pour gaines annelées

## ENTRETOISES DE TUBES PIVOTANTES 2-VOIES - AVEC SUPPORT TUBE ET LANIERE



Form 1



Form 2



Form 3



Form 4

Les schémas ne sont donnés qu'à titre d'exemples, seul le dernier plan de chaque pièce est contractuel.

?	REF.	ØD1	ØD2	l x b	h	e1	Form
	155107	8...9	48...80	-	-	-	1
	061051	10...11	48...80	24 x 10	17,5	16,5	1
	061140	13...14	48...80	25,2 x 12	23,1	17,4	1
	060656	14...16	48...80	35 x 12	21,0	18,0	1
	060725	20...22	48...80	32,5 x 12	28,0	21,0	1
	061186	23...30	48...80	56 x 10	53,0	28,3	1
	060895	23,5...25	48...80	43,5 x 12	33,5	22,0	1
	061303	15...16	90...135	27,5 x 10	21,5	18,0	1
	061032	23,5...25	90...135	43,5 x 12	33,5	22,0	1
	204818	10...12	8...50	25 x 10	16,0	18,0	1
	060787	8...9	8...50	20,5 x 8	13,5	15,0	1
	060698	11...13	8...20	26 x 10	18,5	18,0	1
	061169	15...16	8...50	27,5 x 10	21,5	18,0	1
G	082612	9,6...10,2	8...33	22,15 x 15	14,4	15,2	2
	081549	25,0	8...33	39,5 x 12	37,5	25,0	2
	200183	25,0	30...80	36 x 12,5	37,5	21,5	2
G	082397	6,8...7,4	8...20	21 x 10	11,6	15,55	2
	081203	38...45	8...20	54,5 x 10	56,2	33,5	3
	082635	10...12	8...20	25,5 x 10	14,0	16,5	3
	081410	16...18	8...20	32,5 x 12	20,0	19,5	3
	081445	25...27	8...20	44,5 x 12	32,0	25,0	3
	082610	18...20	8...33	34,75 x 12	22,0	20,25	3
	081439	35...38	8...33	56 x 12	42,6	30,0	3
	201310	38...45	8...33	63,25 x 10	56,2	32,25	3
	082556	38...45	8...33	64,5 x 10	56,2	33,5	3
	082693	12...13	8...50	28,5 x 8	16,0	17,5	3
	081558	25...27	8...50	44,5 x 12	32,0	25,0	3
	082615	10...12	10...52	25,5 x 10	14,0	16,5	3
	081078	16...18	10...52	32,5 x 12	20,0	19,5	3
	201182	13...14	8...33	29,75 x 10	17,0	17,75	3
	201183	35...38	8...33	54,75 x 12	42,6	28,75	3
	080475	46...75	8...20	-	-	13,0	4
	081041	8...33	8...50	-	-	13,0	4
	081290	8...20	8...20	-	-	13,0	4
	080439	8...20	8...33	-	-	13,0	4
	080998	8...20	10...52	-	-	13,0	4
	080984	8...33	46...75	-	-	13,0	4

F = avec raccord  
 G = pour gaines annelées





## ENTRETOISES DE TUBES PIVOTANTES 3-VOIES - AVEC SUPPORT TUBE

**MATIERES:**

Polyamide, résines acétales

**COULEURS:**

Noir, Naturel (autres couleurs, nous consulter)

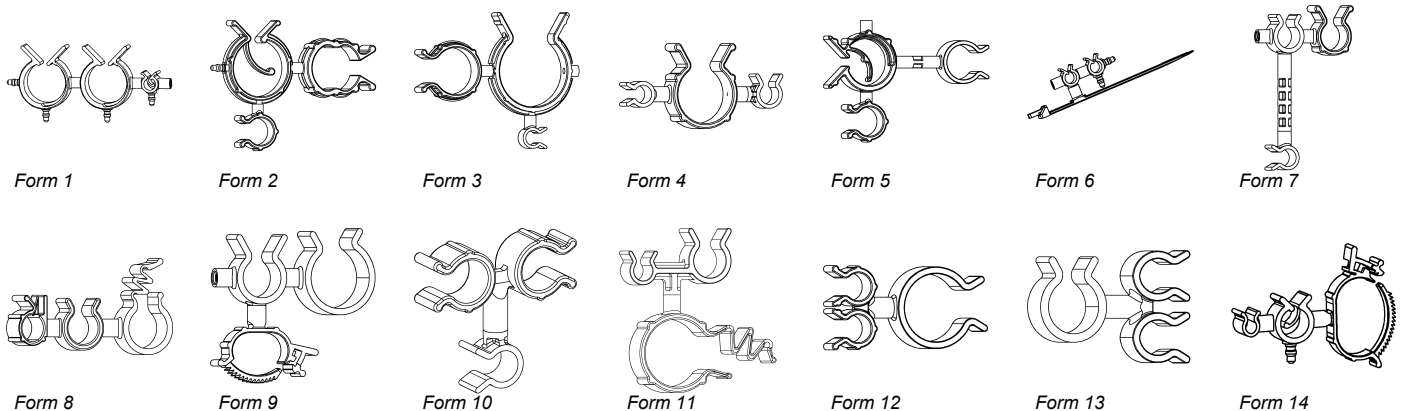
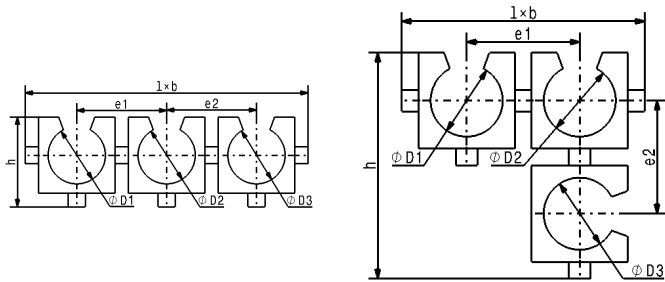

Les schémas ne sont donnés qu'à titre d'exemples, seul le dernier plan de chaque pièce est contractuel.

**Attention!**

Les supports référencés ci-dessous peuvent recevoir des pièces supplémentaires, qui ne sont pas représentées sur les schémas ci-contre.

**? PARTICULARITÉ(S) DE LA PIÈCE**  
Voir correspondance des signes page 4  
Dimensions en mm.

*Échantillons disponibles sur demande*

?	REF.	ØD1	ØD2	ØD3	l x b	h	e1	e2	Form
	082263	3,5...6	24,0	24,0	-	-	26,8	36,7	1
	081419	4...4,5	9...9,5	4,3...5,2	-	-	17,0	16,0	1
	080942	4...4,5	14...16	4,3...5,2	-	-	19,5	19,0	1
	081582	8...9	3,5...5	4,3...5,2	-	-	15,5	17,5	1
	081642	4,3...5,2	11...13	14...15	-	-	18,5	23,0	1
	081651	4,3...5,2	14...16	14...15	-	-	20,0	24,5	1
	061523	4,8...5,2	3,5...6	6...6,5	43,4 x 10	20,0	14,9	17,3	1
	060878	4,8...5,2	10...16	10...16	71,55 x 10	33,85	20,7	28,5	1
	081270	8...9	14...16	4,3...5,2	-	-	21,5	19,0	1
	081147	4,3...5,2	14...16	15...16	-	-	19,0	24,5	1
	081282	19...24,5	23,5...25	4,3...5,2	-	-	31,1	23,0	1
	081421	6...6,5	15,0	8,0	-	-	21,8	14,05	1
	081533	6...6,5	3,5...6	8...9	-	-	17,0	41,0	1
	081210	11...12	11...13	6...6,5	-	-	21,5	19,0	1
	081554	6...6,5	15...16	6...6,5	-	-	21,0	21,0	1
	081559	6...6,5	23,5...25	15...16	-	-	24,5	29,0	1
	060901	6...6,5	23,5...25	23,5...25	88,5 x 12	33,5	25,5	34,0	1
	081271	6...6,5	11...13	6...6,5	-	-	19,0	19,0	1
	190002	7,8...8,5	6...6,5	11,5...13	-	-	17,9	19,0	1
	082630	8...9	7,5...8	8...9	-	-	18,25	20,25	1
	082471	19...24,5	7,5...8	8...9	-	-	23,75	20,25	1
	061534	8...9	16...18	11...13	66,8 x 10	35,5	24,5	25,0	1
	081091	8...9	11...13	11,5...13	-	-	20,0	21,5	1
	081491	14...15	11...13	8...9	-	-	23,0	20,0	1
	081380	18...20	11...13	8...9	-	-	24,5	22,0	1
	081072	8...9	11...13	7,8...8,5	-	-	20,0	18,7	1
	061402	8...9	13...14	13...14	67,5 x 10	20,0	21,0	23,5	1

E = avec languette pour diamètre variable  
F = avec raccord  
G = pour gaines annelées

## ENTRETOISES DE TUBES PIVOTANTES 3-VOIES - AVEC SUPPORT TUBE

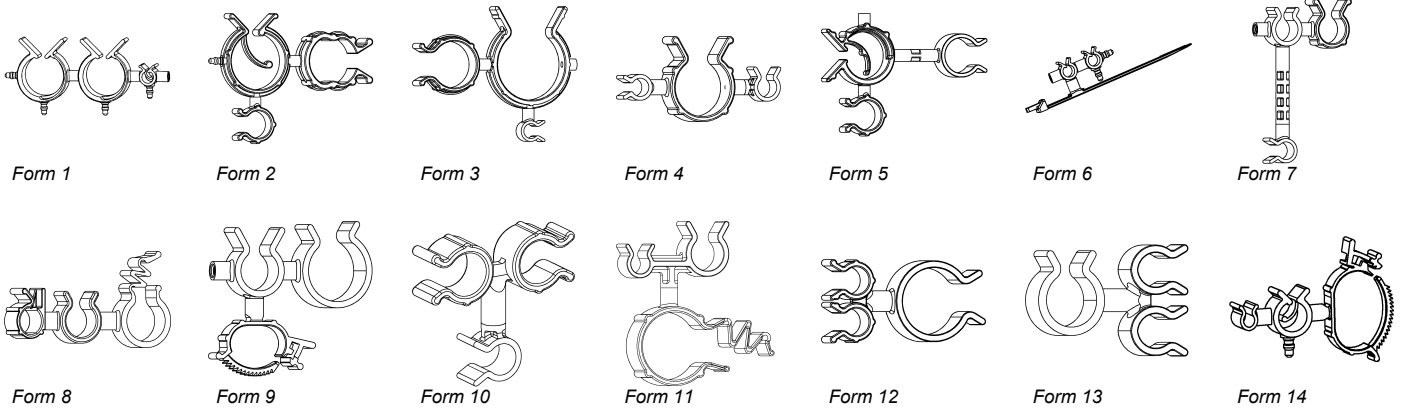

Les schémas ne sont donnés qu'à titre d'exemples, seul le dernier plan de chaque pièce est contractuel.

?	REF.	ØD1	ØD2	ØD3	l x b	h	e1	e2	Form
	081269	8...9	14...16	8...9	-	-	21,5	23,5	1
	061715	8...9	14...16	8...9	58 x 12	22,0	21,5	23,5	1
	061595	8...9	16...18	8...9	63,3 x 10	35,5	25,3	24,0	1
	060993	8...9	39...45	11...13	90 x 10	63,5	34,0	34,5	1
	061600	8...9	23...24	11...13	72,7 x 10	46,7	27,4	29,3	1
	061389	8...9	26...28	16...18	85,3 x 12	42,8	27,5	32,4	1
	061104	9...9,5	9...9,5	23...30	93,5 x 10	55,0	19,0	29,0	1
	060948	9...9,5	9...9,5	23,5...25	72,5 x 12	33,5	19,0	26,0	1
	061297	9...9,5	23...30	9...9,5	90,1 x 10	53,0	31,8	32,2	1
	061312	9,5...10,5	9...9,5	11...13	59,5 x 10	18,5	19,5	20,5	1
	081561	9,5...10,5	10...16	10...12	-	-	23,75	26,5	1
	061295	9,5...10,5	13...14	13...14	63,2 x 10	20,5	21,7	23,5	1
	060892	9,5...10,5	11...13	11...13	66,5 x 10	17,5	20,0	21,5	1
	061227	9,5...10,5	23,5...25	23,5...25	92,8 x 12	33,5	27,0	34,0	1
	080931	19...24,5	23...25	9,5...10,5	-	-	31,8	26,25	1
	081460	10...12	38...45	11,5...13	-	-	37,0	34,5	1
	081214	10...12	11...13	14...15	-	-	23,0	23,0	1
	081092	19...24,5	11...13	11,5...13	-	-	25,5	21,5	1
	081018	11,5...13	11...13	11...13	-	-	21,5	21,5	1
	061572	11...13	11...13	15...16	68,5 x 10	23,0	21,5	23,0	1
	201010	11...13	14...16	28...30	-	-	23,0	32,0	1
	060733	11...13	23,5...25	23,5...25	89 x 12	34,0	27,0	34,0	1
	061063	11...13	14...16	14...16	80 x 12	22,0	23,2	24,5	1
	060812	11...13	11...13	18...20	66,4 x 12	26,8	21,5	24,5	1
	060990	11...13	11...13	11...13	78 x 10	18,5	21,5	21,5	1
	081030	11...13	11...13	11...13	-	-	21,5	21,5	1
	080970	19...24,5	9...9,5	11,5...13	-	-	24,5	20,0	1
	061509	11...13	9...9,5	23...30	89,3 x 10	55,0	20,1	30,0	1
	081646	11,5...13	6...6,5	15...16	-	-	19,0	20,5	1
	082685	11,5...13	23...25	11...13	-	-	27,0	27,5	1
	061326	23,5...25	11...13	11...13	83,8 x 12	34,5	24,5	27,0	1
	081062	19...24,5	23,5...25	11,5...13	-	-	31,0	27,0	1
	081175	13...14	16...24	22...24	-	-	29,9	34,8	1
	081571	13...14	13...14	4,3...5,2	-	-	23,5	18,5	1
	081385	22...24	13...14	13...14	-	-	28,0	23,5	1
	061644	13...14	14...16	23,5...25	82,5 x 12	35,5	24,0	29,0	1
	081502	13...14	23,5...25	7,8...8,5	-	-	28,5	24,2	1
	201055	13...14	34...36	26...28	-	-	34,5	40,5	1
	200013	19...24,5	34...36	13...14	-	-	37,5	34,5	1
	081342	14...15	14...16	19...24,5	-	-	24,5	27,3	1
	081306	18...20	14...16	14...15	-	-	26,0	24,5	1
	081610	14...15	14...16	13...14	-	-	24,5	24,0	1
	061652	14...16	23,5...25	18...20	81 x 12	34,5	29,0	31,0	1
	061513	14...16	39...45	18...20	108,3 x 12	62,0	37,2	39,5	1
	061258	14...16	14...16	18...20	82,5 x 12	26,0	24,5	26,0	1
	061062	14...16	11...13	14...16	80 x 12	22,0	23,2	23,2	1
	081448	15...16	15...16	15...16	-	-	25,0	25,0	1

E = avec languette pour diamètre variable  
 F = avec raccord  
 G = pour gaines annelées

## ENTRETOISES DE TUBES PIVOTANTES 3-VOIES - AVEC SUPPORT TUBE

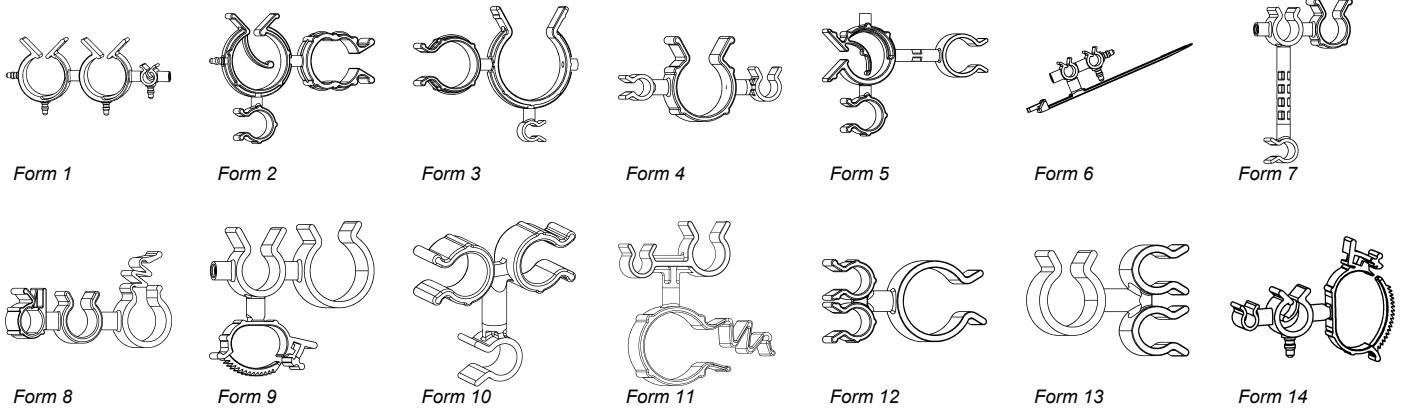

Les schémas ne sont donnés qu'à titre d'exemples, seul le dernier plan de chaque pièce est contractuel.

?	REF.	ØD1	ØD2	ØD3	l x b	h	e1	e2	Form
	<b>082592</b>	38...45	15...16	15...16	-	-	36,5	25,0	1
	<b>061007</b>	15...16	14...16	23,5...25	86 x 12	33,5	29,0	28,5	1
	<b>081185</b>	15...16	23,5...25	38...45	-	-	29,0	41,0	1
	<b>082606</b>	38...45	23...25	16...18	-	-	40,5	29,5	1
	<b>200456</b>	18...20	11...13	11,5...13	-	-	24,5	21,5	1
	<b>060863</b>	18...20	14...16	23,5...25	85 x 12	33,5	26,0	29,5	1
	<b>061315</b>	18...20	39...45	39...45	104 x 12	63,0	39,0	40,5	1
	<b>081254</b>	22...24	14...16	19...24,5	-	-	28,5	27,0	1
	<b>082539</b>	23...25	23...25	19...24,5	-	-	33,0	31,1	1
	<b>081016</b>	19...24,5	23...25	22...24	-	-	31,1	32,5	1
	<b>081162</b>	19...24,5	23,5...25	38...45	-	-	31,6	41,0	1
F	<b>082468</b>	38...45	38...45	19...24,5	-	-	63,0	39,5	1
	<b>061718</b>	20...22	9...9,5	22...24	78,3 x 12	30,0	24,5	25,5	1
	<b>061333</b>	23,5...25	23,5...25	23,5...25	112 x 12	34,5	34,0	34,0	1
	<b>081607</b>	38...45	23,5...25	23,5...25	-	-	41,0	33,0	1
	<b>082084</b>	38...45	13...14	38...45	-	-	35,5	36,5	1
	<b>081245</b>	13...14	13...14	11,5...13	-	-	22,4	22,4	1
	<b>190001</b>	34...36	6...6,5	4...4,5	-	-	31,0	15,5	2
G	<b>081635</b>	6,8...7,4	11...13	8...9	-	-	18,55	20,0	2
	<b>081713</b>	22...24	11...13	13...14	-	-	45,5	23,0	2
	<b>081821</b>	13...14	13...14	13...14	-	-	23,5	23,5	2
	<b>082458</b>	8...9	22...23	8...9	-	-	25,5	25,5	2
	<b>082563</b>	25...27	22...23	7,8...8,5	-	-	35,5	25,9	2
	<b>061731</b>	29...33	23...24	13...14	85,7 x 12	62,4	38,3	23,9	2
E	<b>201107</b>	22...30	23...30	15...16	-	-	43,05	34,75	2
	<b>082289</b>	25...27	38...45	8...9	-	-	44,0	35,5	2
	<b>061593</b>	13...14	16...18	9,5...11	59,8 x 10	52,0	26,5	27,0	2
	<b>061554</b>	13...14	16...18	15...16	55,3 x 10	52,0	27,0	26,5	2
	<b>061574</b>	20...22	16...18	11...13	53 x 12	61,3	29,5	25,5	2
	<b>061710</b>	20...22	10...16	8...9	59,5 x 12	46,0	32,0	23,5	2
	<b>081976</b>	6...6,5	13...14	6...6,5	-	-	20,0	20,0	2
	<b>082274</b>	18...20	34...36	18...20	-	-	36,5	36,5	2
	<b>061404</b>	18...20	16...18	11...13	58,5 x 12	54,65	28,5	24,7	3
	<b>081908</b>	19...24,5	38...45	12...13	-	-	40,6	36,5	3
	<b>061663</b>	18...20	24,0	4,8...5,2	66,9 x 12	53,1	31,9	25,7	3
	<b>061070</b>	6...10	24,0	6...10	63 x 10	70,0	28,7	28,7	3
	<b>061708</b>	13...14	13,0	9,5...11	48 x 10	29,5	23,5	24,0	3
	<b>061472</b>	9,5...11	10...16	8...9	52,3 x 10	47,15	30,0	26,0	3
	<b>061331</b>	11...13	10...11,5	6...6,5	39 x 10	36,25	21,0	19,0	3
	<b>061536</b>	13...14	13,0	8...9	49 x 10	43,5	23,5	21,0	3
	<b>061641</b>	14,5...16	13,0	15...16	51,7 x 10	49,5	24,3	24,0	3
	<b>061049</b>	15...16	10...16	9...9,5	55 x 10	55,4	26,4	23,4	3
	<b>061700</b>	23,5...25	10...11,5	18...20	56,5 x 12	57,0	27,3	24,6	3
	<b>061508</b>	23...30	16...24	11...13	91 x 10	74,9	33,7	31,5	3

E = avec languette pour diamètre variable  
 F = avec raccord  
 G = pour gaines annelées

## ENTRETOISES DE TUBES PIVOTANTES 3-VOIES - AVEC SUPPORT TUBE

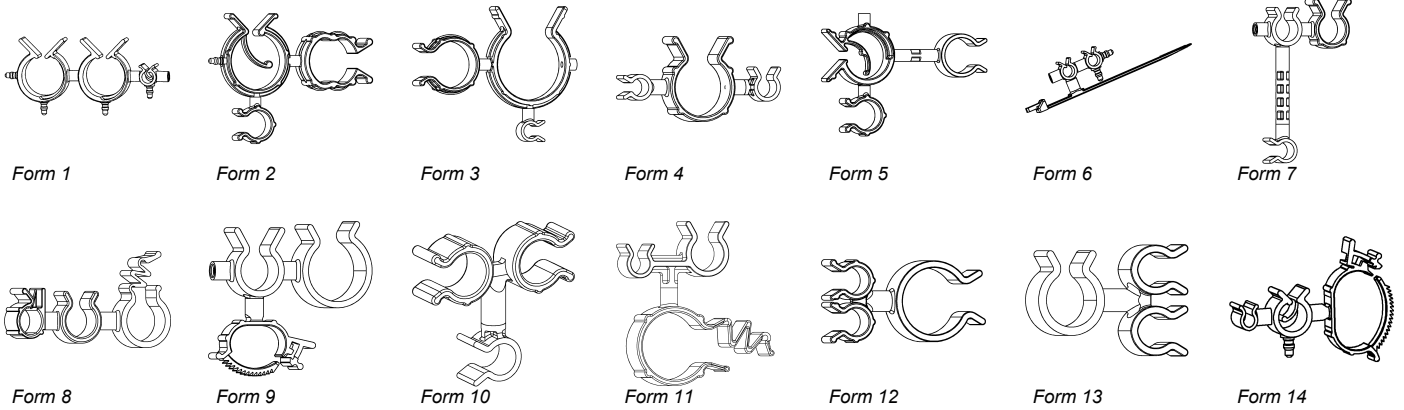

Les schémas ne sont donnés qu'à titre d'exemples, seul le dernier plan de chaque pièce est contractuel.

?	REF.	ØD1	ØD2	ØD3	l x b	h	e1	e2	Form
	081293	6...6,5	11...13	38...45	-	-	19,0	37,0	4
	061236	6...6,5	6...6,5	18...20	59,75 x 12	24,0	16,5	22,5	4
	081771	7,2...7,5	23,5...25	11...13	-	-	25,6	27,0	4
G	082027	8...9	9...9,5	6,8...7,4	-	-	20,5	19,55	4
	082122	7,2...7,5	23...25	8...9	-	-	25,6	27,5	4
	081164	7,2...7,5	38...45	7,8...8,5	-	-	33,6	31,7	4
	061721	9...9,5	9...9,5	16...18	65 x 12	21,0	19,0	22,5	4
	081486	11,5...13	11...13	7,2...7,5	-	-	21,5	19,6	4
	082340	11...13	11...13	10...12	-	-	21,5	21,0	4
G	200632	11...13	14...16	6,8...7,4	-	-	23,0	20,05	4
	082283	13...14	13...14	11,5...13	-	-	24,0	22,75	4
	081668	13...14	9...9,5	18...20	-	-	21,5	23,5	4
	081396	13...14	14...16	14...15	-	-	24,5	24,5	4
	081527	10...12	11...13	19...24,5	-	-	21,0	25,1	4
	081063	38...45	16...24	28...30	-	-	42,3	38,0	4
	082174	25...27	14...16	48...53	-	-	31,5	42,65	4
	081116	13...14	11...13	7,2...7,5	-	-	22,5	19,6	5
	081520	8...9	13...14	7,2...7,5	-	-	23,0	20,6	5
	082022	14...15	11...13	13...14	-	-	23,0	23,0	5
	081731	11,5...13	13...14	13...14	-	-	22,5	24,0	5
	082488	18...20	16...24	15...16	-	-	50,9	30,4	5
	081095	16...18	38...45	10...12	-	-	40,0	37,0	5
	081700	6...6,5	6...6,5	8...20	-	-	15,5	-	6
	081600	6...6,5	6...6,5	8...20	-	-	15,5	-	6
	081248	10...12	38...45	4...4,5	-	-	38,5	32,0	7
	081683	11...13	7,8...8,5	4...4,5	-	-	19,6	15,2	7
	061870	6...6,5	22...23	6...6,5	45,7 x 12	47,6	24,5	24,5	7
	081699	6...6,5	6...6,5	19...24,5	-	-	16,5	22,6	7
E	200034	7,8...8,5	23...30	25...27	-	-	32,15	41,75	7
	201389	8...9	34...36	11...13	-	-	32,0	33,5	7
	081335	19...24,5	16...24	9,5...10,5	-	-	32,5	28,55	7
	081734	11,5...13	10...16	7,8...8,5	-	-	24,5	23,9	7
	081712	11...13	13...14	11...13	-	-	22,5	22,5	7
	082139	11...13	11...13	11...13	-	-	21,5	21,5	7
E	200835	11...13	16...24	18...20	-	-	28,9	31,9	7
	081108	8...9	11...13	13...14	-	-	55,0	22,5	7
	081102	13...14	11...13	8...9	-	-	22,5	20,0	7
	190007	13...14	6...6,5	6...6,5	-	-	20,0	16,5	7
	081176	13...14	11...13	10...12	-	-	22,5	23,0	7
	081495	13...14	13...14	19...24,5	-	-	23,5	26,1	7
	081283	13...14	11...13	8...9	-	-	38,0	20,0	7
	082149	13...14	38...45	8...9	-	-	36,5	35,0	7
	081441	7,8...8,5	16...24	7,8...8,5	-	-	26,5	27,8	7
	081467	16...24	3,5...6	4...4,5	-	-	26,8	15,5	7

E = avec languette pour diamètre variable  
 F = avec raccord  
 G = pour gaines annelées



## ENTRETOISES DE TUBES PIVOTANTES 3-VOIES - AVEC SUPPORT TUBE

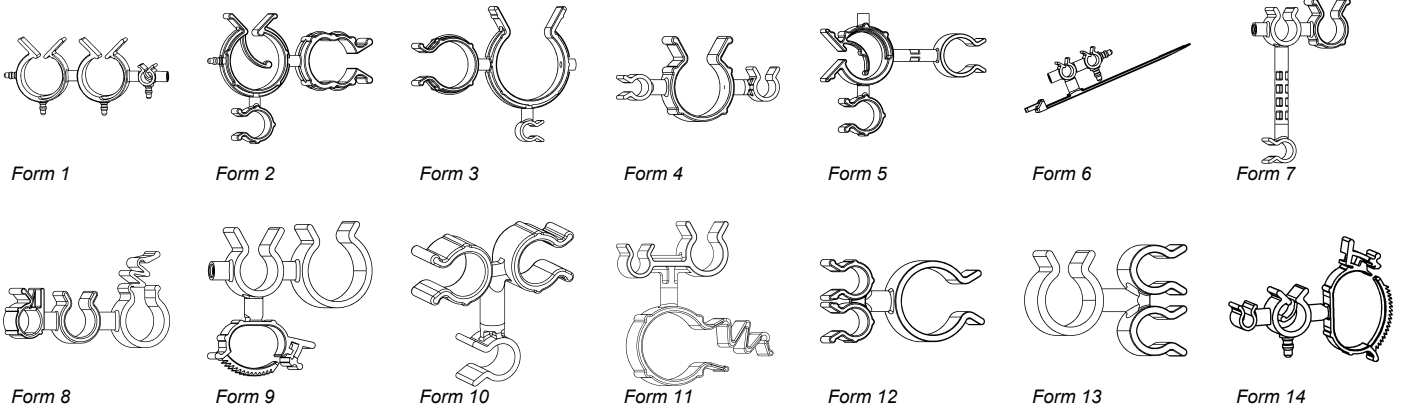

Les schémas ne sont donnés qu'à titre d'exemples, seul le dernier plan de chaque pièce est contractuel.

?	REF.	ØD1	ØD2	ØD3	l x b	h	e1	e2	Form
	<b>081954</b>	18...20	13...14	15...16	-	-	25,5	24,0	7
	<b>081243</b>	22...24	38...45	19...24,5	-	-	40,0	40,6	7
	<b>200007</b>	28...30	38...45	8...9	-	-	43,5	33,5	7
	<b>081034</b>	15...16	38...45	38...45	-	-	38,5	54,0	7
G	<b>082671</b>	4,3...5,2	3,5...5	20,6...21,4	-	-	16,0	24,0	8
	<b>081914</b>	7,8...8,5	11...13	14,0	-	-	18,7	23,5	8
	<b>190050</b>	13...14	9...9,5	25,0	-	-	21,4	27,0	8
	<b>190039</b>	15...16	9...9,5	25,0	-	-	22,0	27,0	8
G	<b>082548</b>	11,5...13	7,5...8	9,6...10,2	-	-	20,0	20,2	8
	<b>201348</b>	19...24,5	13...14	10...14	-	-	26,5	24,8	9
	<b>081617</b>	11...12	11...12	13...14	-	-	20,5	24,0	10
	<b>081770</b>	13,5	13,5	7,8...8,5	-	-	21,0	16,7	10
G	<b>082697</b>	4,0	4,0	20,6...21,4	-	-	12,0	24,0	11
	<b>081851</b>	4,0	4,0	22,0	-	-	12,0	25,0	11
G	<b>082590</b>	5,0	5,0	12,6...13,2	-	-	16,0	19,85	11
G	<b>082215</b>	5,0	12,6...13,2	17,0	-	-	11,6	26,15	11
	<b>082618</b>	6,0	6,0	10...14	-	-	14,0	18,8	11
	<b>081824</b>	6,0	6,0	22,0	-	-	14,0	25,0	11
	<b>081953</b>	13...14	7,5...8	25,0	-	-	25,0	32,5	11
G	<b>082046</b>	8...9	8...9	6,8...7,4	-	-	12,0	16,55	11
G*	<b>082169</b>	8...9	8...9	9,6...10,2	-	-	12,0	17,95	11
	<b>082481</b>	8...9	8...9	16...22	-	-	12,0	22,4	11
	<b>082673</b>	9...10,5	9...10,5	16...22	-	-	16,0	24,9	11
	<b>082205</b>	9...10,5	9...10,5	25,0	-	-	16,0	29,0	11
	<b>082703</b>	25...27	25...27	33...35	-	-	32,0	37,0	11
	<b>200946</b>	4,0	4,0	18...20	-	43,5	12,0	23,0	12
	<b>081416</b>	6,0	6,0	13...14	-	39,5	14,0	20,5	12
	<b>081452</b>	6...6,5	8...9	35...38	-	64,5	11,0	31,5	12
	<b>081461</b>	6...6,5	8...9	18...20	-	45,0	11,0	23,0	12
	<b>081485</b>	6...6,5	8...9	13...14	-	40,5	11,0	20,5	12
	<b>081101</b>	6...6,5	8...9	10...12	-	36,0	11,0	19,0	12
	<b>081343</b>	6,0	6,0	22...30	-	59,0	14,0	29,0	12
	<b>081552</b>	13...14	7,5...8	13...14	-	50,5	25,0	27,0	12
	<b>081028</b>	8...9	8...9	10...12	-	36,0	12,0	19,0	12
	<b>201106</b>	8...9	8...9	20...22	-	46,75	12,0	23,75	12
	<b>061695</b>	8...9	8...9	34...36	57 x 10	67,5	12,0	31,5	12
	<b>060869</b>	8...9	8...9	18...20	25 x 12	46,0	12,0	23,0	12
	<b>081616</b>	8...9	8...9	28...30	-	59,0	12,0	28,5	12
	<b>081779</b>	9...10,5	9...10,5	10...12	-	39,5	16,0	21,5	12
	<b>081941</b>	9...10,5	9...10,5	18...20	-	48,5	16,0	25,5	12
	<b>081780</b>	13,5	13,5	13...14	-	-	21,0	20,5	12
	<b>061101</b>	13...15	13...15	18...20	38 x 12	52,5	19,0	23,5	12

E = avec languette pour diamètre variable  
 F = avec raccord  
 G = pour gaines annelées

## ENTRETOISES DE TUBES PIVOTANTES 3-VOIES - AVEC SUPPORT TUBE

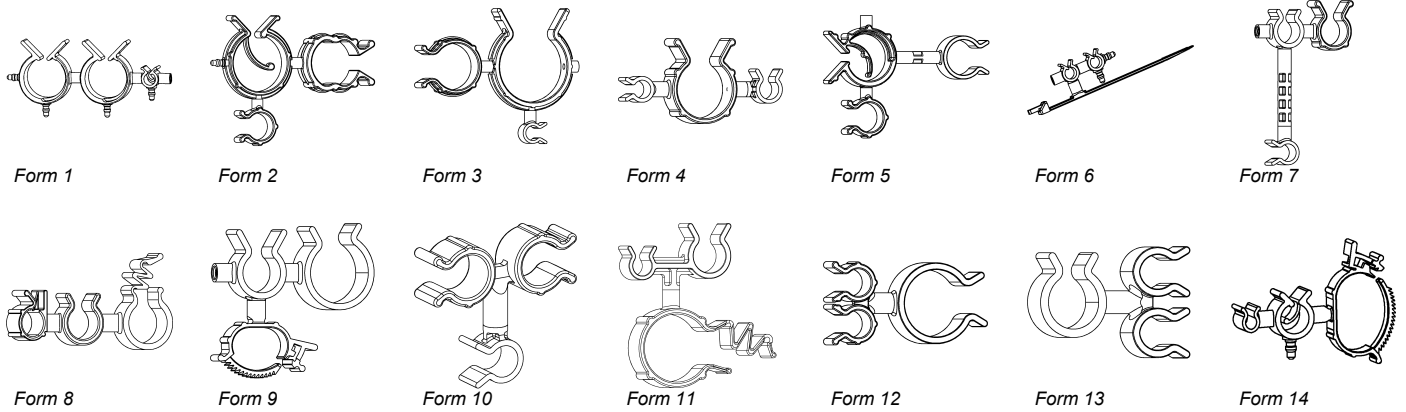

Les schémas ne sont donnés qu'à titre d'exemples, seul le dernier plan de chaque pièce est contractuel.

?	REF.	ØD1	ØD2	ØD3	l x b	h	e1	e2	Form
	081423	13...14	7,5...8	7,2...7,5	-	42,1	25,0	23,6	12
	081114	13...14	13...14	18...20	-	51,5	19,0	23,5	12
	081427	13...14	13...14	28...30	-	65,5	19,0	29,0	12
	061440	13...15	13...15	16...18	41 x 10	55,9	19,0	23,9	12
	081302	13,5	13,5	10...12	-	40,0	21,0	19,0	12
	061421	13...15	13...15	23...24	45,2 x 10	64,4	19,0	27,4	12
	061635	13...15	13...15	30...32	47 x 10	73,5	19,0	31,5	12
	061216	13...15	13...15	39...45	57,3 x 10	82,0	19,0	36,0	12
	061431	13...15	13...15	29...33	36 x 12	71,20	19,0	28,9	12
	081810	16...17	16...17	4,3...5,2	-	-	22,0	16,0	12
	082551	16...17	16...17	35...38	-	72,0	22,0	32,0	12
	081310	16...17	16...17	38...45	-	80,5	22,0	35,5	12
	081472	16...17	16...17	28...30	-	65,5	22,0	29,0	12
	081347	25...27	25...27	29...30	-	76,5	32,0	33,5	12
	081605	4,0	4,0	6...6,5	-	-	12,0	17,0	13
	082297	4,0	4,0	11,5...13	-	-	12,0	19,5	13
	081584	6,0	6,0	9,5...10,5	-	-	14,0	18,75	13
	081759	6,0	6,0	14...15	-	-	14,0	21,0	13
	081523	6,0	6,0	16...18	-	-	14,0	22,0	13
	081398	6,0	6,0	22...24	-	-	14,0	25,0	13
	082037	8...9	6...6,5	4,3...5,2	-	-	11,0	15,5	13
	082622	8...9	6...6,5	6...6,5	-	-	11,0	17,0	13
	081889	8...9	6...6,5	22...24	-	-	11,0	48,5	13
	081247	8...9	6...6,5	11...13	-	-	11,0	19,5	13
	081487	8...9	6...6,5	11,5...13	-	-	11,0	19,5	13
	081453	8...9	6...6,5	22...24	-	-	11,0	48,5	13
	081678	8...9	6...6,5	9,5...10,5	-	-	11,0	18,75	13
	081969	6...6,5	6...6,5	8...9	-	-	14,0	20,0	13
	081473	6...6,5	6...6,5	4,3...5,2	-	-	14,0	15,5	13
	061628	7,0	7,0	6...6,5	25 x 8	30,5	12,0	15,5	13
	060879	8...9	8...9	10...16	33,5 x 10	49,3	12,0	23,5	13
	060884	8...9	8...9	11...13	23 x 10	36,0	12,0	19,5	13
	200338	8...9	8...9	16...18	-	-	12,0	22,0	13
	061328	8...9	8...9	4,2...5,2	23 x 10	27,8	12,0	14,3	13
	081152	8...9	8...9	7,8...8,5	-	-	12,0	16,7	13
	080490	8...9	8...9	14...15	-	-	12,0	21,0	13
	081639	8...9	8...9	6...6,5	-	-	12,0	17,0	13
	080493	8...9	8...9	19...24,5	-	-	12,0	30,0	13
	060816	8...9	8...9	14...15	25,3 x 12	46,0	12,0	21,0	13
	080915	8...9	8...9	19...24,5	-	-	12,0	39,0	13
	081094	8...9	8...9	22...24	-	-	12,0	25,0	13
	061254	8...9	8...9	9,5...10,5	27 x 10	35,0	12,0	19,0	13
	081685	8...9	8...9	18...20	-	-	12,0	29,0	13
	081317	8...9	8...9	8...9	-	-	12,0	20,0	13
	081451	8...9	8...9	38...45	-	-	12,0	33,5	13
	081869	8...9	8...9	6...6,5	-	-	12,0	23,5	13

E = avec languette pour diamètre variable  
F = avec raccord  
G = pour gaines annelées



## ENTRETOISES DE TUBES PIVOTANTES 3-VOIES - AVEC SUPPORT TUBE ET LANIERE

**MATIERES:**

Polyamide, résines acétales

**COULEURS:**

Noir, Naturel (autres couleurs, nous consulter)

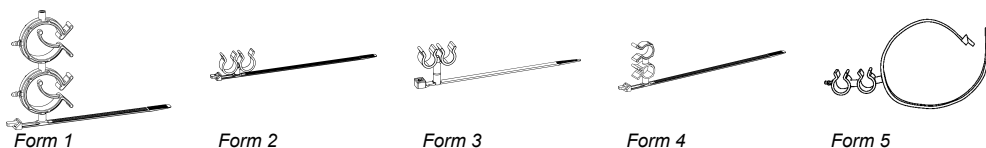
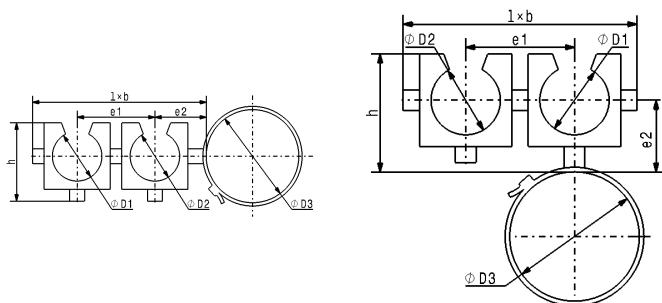

Les schémas ne sont donnés qu'à titre d'exemples, seul le dernier plan de chaque pièce est contractuel.

**NOTA:**

Les supports référencés ci-dessous peuvent comporter des éléments supplémentaires (embases mâles ou femelles, languettes de retenue pour diamètres variables, etc.) qui ne figurent pas sur les schémas ci-contre.

**?** PARTICULARITÉ(S) DE LA PIÈCE  
Voir correspondance des signes page 4  
Dimensions en mm.

*Échantillons disponibles sur demande*

?	REF.	ØD1	ØD2	ØD3	l x b	h	e1	e2	Form
E	<b>081440</b>	16...24	16...24	8...33	83,4 x 10	44,9	36,7	25,4	1
E	<b>082421</b>	23...30	23...30	8...33	100,6 x 10	53,25	45,3	29,75	1
	<b>060931</b>	8...9	8...9	8...50	55 x 10	22,0	12,0	-	2
	<b>081123</b>	13...14	13...14	8...50	36 x 10	29,0	19,0	-	2
	<b>081412</b>	13...14	13...14	8...75	36 x 10	29,0	19,0	-	2
	<b>081553</b>	13...14	13...14	10...52	36 x 10	29,0	19,0	-	2
	<b>081313</b>	16...17	16...17	10...52	42 x 10	29,0	22,0	-	2
	<b>082257</b>	9...10,5	9...10,5	8...20	29 x 10	26,0	16,0	-	2
	<b>081640</b>	7,5...8	13...14	8...33	38,5 x 10	30,0	25,0	-	2
	<b>082627</b>	6,0	6,0	8...50	25 x 9	21,5	14,0	-	2
	<b>082626</b>	6...6,5	8...9	8...50	21 x 8	22,5	11,0	-	2
	<b>081741</b>	8...9	8...9	46...95	25 x 8	22,5	12,0	-	2
	<b>081067</b>	8...9	8...9	8...20	25 x 8	22,5	12,0	-	2
	<b>081652</b>	13...14	13...14	30...80	36 x 10	42,5	19,0	-	3
	<b>082279</b>	9...10,5	9...10,5	8...33	29 x 10	32,75	16,0	-	3
	<b>081221</b>	6...6,5	11...13	10...52	40 x 10	17,5	19,0	16,5	4
	<b>081073</b>	6...6,5	11...13	46...95	40 x 10	17,5	19,0	16,5	4
	<b>081951</b>	8...9	7,5...8	8...20	33 x 10	13,75	18,25	14,75	4
	<b>082515</b>	14...15	14...16	8...33	140 x 12	21,0	24,5	18,25	4
	<b>081799</b>	13...14	13...14	10...52	48,3 x 12	25,0	22,4	17,4	4
	<b>060964</b>	14...16	14...16	48...80	59,5 x 12	21,0	24,5	18,0	5

E = avec languette pour diamètre variable

## ENTRETOISES DE TUBES PIVOTANTES 4-VOIES - AVEC SUPPORT TUBE

**MATIERES:**

Polyamide, résines acétales

**COULEURS:**

Noir, Naturel (autres couleurs, nous consulter)

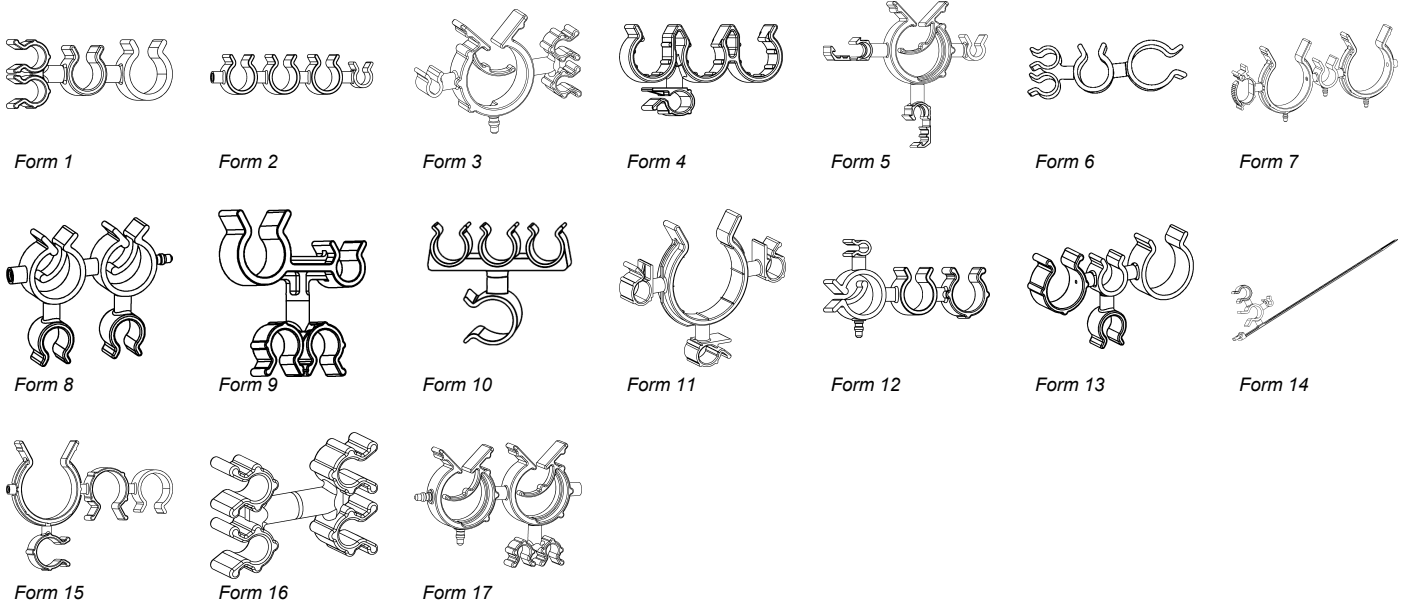
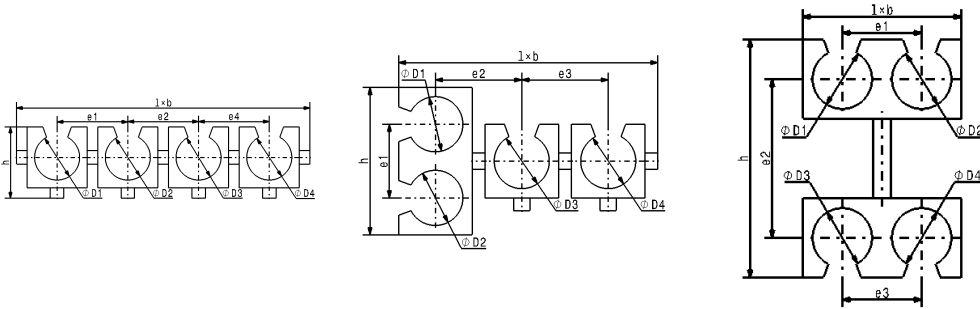

Les schémas ne sont donnés qu'à titre d'exemples, seul le dernier plan de chaque pièce est contractuel.

**NOTA:**

Les supports référencés ci-dessous peuvent contenir des pièces supplémentaires, (embases mâles ou femelles, languettes de retenue pour diamètres variables, etc.) qui ne sont pas représentés sur les schémas ci-contre.

**? PARTICULARITÉ(S) DE LA PIÈCE**  
Voir correspondance des signes page 4  
Dimensions en mm.

Échantillons disponibles sur demande

?	REF.	ØD1	ØD2	ØD3	ØD4	l x b	h	e1	e2	e3	Form
	<b>081060</b>	8...9	8...9	11,0	14...15	59,5 x 10	25,0	12,0	19,5	23,0	1
	<b>081977</b>	8...9	8...9	11...13	22...24	67,5 x 12	25,0	12,0	19,5	27,0	1
	<b>061024</b>	8,0	8,0	11...13	14...16	67,5 x 12	-	12,0	19,5	23,0	1
	<b>082192</b>	8...9	14...16	14...16	14...16	91 x 12	21,0	21,5	24,5	24,5	2
	<b>081090</b>	4...4,5	11...13	11...13	22...24	83 x 12	29,5	18,0	21,5	27,0	2
	<b>060930</b>	8...9	14...16	14...16	4,8...5,2	20 x 12	75,8	19,0	24,5	21,5	2
	<b>081649</b>	11,5...13,5	11...13	11...13	11...13	87,75 x 10	17,5	21,5	21,5	21,5	2
	<b>081705</b>	6,0	6,0	16...24	4,3...5,2	62,55 x 10	25,0	14,0	26,9	25,3	3
	<b>082198</b>	13,5	13,5	13,5	7,8...8,5	61 x 12	-	21,0	21,0	16,7	4
	<b>081818</b>	13,5	13,5	13,5	11,5...13	61 x 11	39,25	21,0	21,0	19,5	4
G	<b>082638</b>	6,8...7,4	16...24	6...6,5	6,8...7,4	- x 10	-	27,95	26,8	27,95	5
	<b>061443</b>	8...9	8...9	14...16	18...20	67,5 x 12	24,0	12,0	21,0	26,5	6
	<b>082085</b>	10...14	38...45	13...14	38...45	137 x 10	60,0	30,8	35,5	36,5	7

G = pour gaines annelées





