

SUPPORTS DE TUBES A SOUDER OU COLLER PLASTIQUE OU METAL

MATIERES:

Polyamide, polypropylène, polyéthylène avec grande densité, aluminium

COULEURS:

Noir

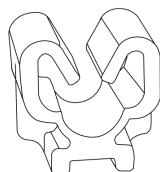
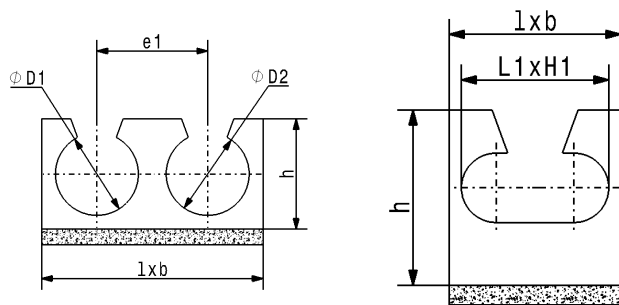

Form 1

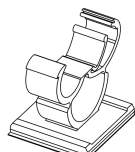

Form 2

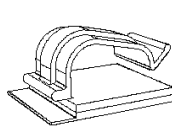

Form 3



Form 4

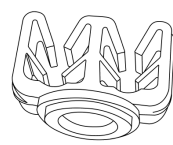

Form 5

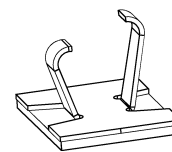

Form 6

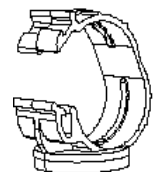

Form 7

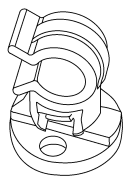

Form 8

Les schémas ne sont donnés qu'à titre d'exemples, seul le dernier plan de chaque pièce est contractuel.

FORME 1, 4, 5 et 7: SUPPORTS À SOUDER (réservoir en polyéthylène)

FORME 2, 3 et 6: SUPPORTS À COLLER (avec adhésif double face).

REF. 060988: Support avec diamètre variable et verrouillage automatique.

? **PARTICULARITÉ(S) DE LA PIÈCE**
Voir correspondance des signes page 4
Dimensions en mm.

Échantillons disponibles sur demande

?	REF.	ØD1	ØD2	L1 x H1	l x b	e1	h	s	Form
	055585	5,8...6,2	-	-	15,8 x 16	-	16,0	-	1
	060988	6...12	-	-	25 x 25	-	27,0	-	2
	108011	-	-	18 x 10	27 x 22	-	15,0	-	3
	055097	4,7...5,05	4,7...5,05	-	38 x 24	18,0	44,5	-	4
	055096	8...10	8...10	-	36 x 25	16,0	24,0	-	5
	055588	12,6...13,4	7,6...8,4	-	39,7 x 24,5	16,2...17,8	30,5	-	5
	080667	5,0	-	-	15,8 x 11,1	-	9,5	0,45	6
	080668	8,0	-	-	19 x 15,9	-	14,8	0,75	6
	108157	23,0	-	-	38,5 x 24	-	31,0	-	7
	208842	11,0	-	-	18,0	-	27,0	-	8
	205200	8,0	-	-	18,0	-	22,8	-	8